



SERTPLAS®

SYSTEMS

Product Catalogue 2022-2023



ELECTRIC — LIGHTING — AIR

www.sertplas.com.tr

 SEERTAS[®]



POWER PLANT

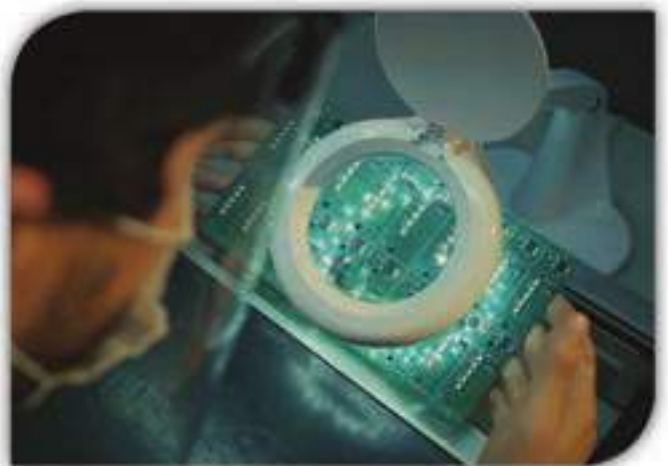
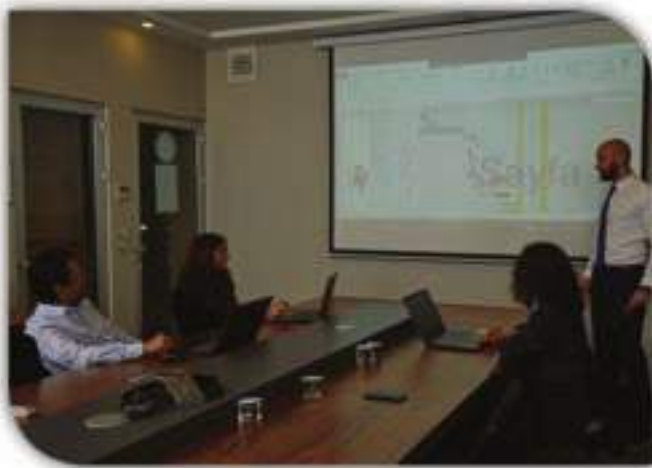

Company Profile

SERTPLAS is a well-established technology manufacturer that takes its power from the principles of perfect production and ultimate customer satisfaction.

SERTPLAS is providing design, development, manufacturing, assembly and other various services to OEMs and commercial vehicle aftermarket in accordance with the IATF 16949 quality standards.

The Research and Development center established within the company, SERTPLAS is producing 100 % domestic, high technology products that include embedded software in their core.

SERTPLAS is representing Turkish design and engineering in the global arena by exporting 86 % of its production.

Company History

SERTPLAS stepped into the market in 1955 as a small plastic injection shop, by its founder Hasan Serter (1931 - 2002). Today the company is operating out of a vertically integrated complete production facility established on an area of 40,000m² with net production area of 11,500m², supplying both the aftermarket and OEMs.

In addition to truck and trailer lighting equipment, SERTPLAS expanded its product portfolio to include electrical/electronic systems, electric cables, connectors, body parts, air brake hoses and couplings, convertors and regulators.

By paying close attention to the market dynamics and changing customer requirements, SERTPLAS is proudly exporting 86 % of its production to 60 countries in Europe, Africa, Middle East, Asia and South America, as well as directly working with OEMs around the globe as a preferred Tier 1 supplier.

From design to mass production, SERTPLAS is proud to be a preferred solution partner for many customers around the world.

Our Vision

To further build our brand as a globally leading technology manufacturer for electric and heavy duty vehicles.

Our Mission

- ❖ Without sacrificing quality, to keep customer satisfaction at the highest level and always move our production forward by using the state of the art manufacturing principles and techniques.
- ❖ Investing in Research and Development projects that re-define the future of the industries that we participate in.
- ❖ Expand the limits of our internal expertise to provide new products that address the future challenges of our clients
- ❖ We create an environment in which our colleagues can grow and explore their potential in moving our collective effort that is called SERTPLAS further.

Şirket Profili

Müşteri memnuniyetini ilke edinmiş köklü bir şirket olan SERTPLAS, gücünü daima yeni teknolojilerle beslediği kusursuz üretim anlayışından alıyor.

SERTPLAS, IATF 16949 kalite standartları çerçevesinde otomotiv ve ağır vasıta üreticilerine tasarım, geliştirme, üretimi, montaj ve servis hizmetleri sunmaktadır.

Bünyesinde kurduğu Araştırma ve Geliştirme merkezi ile gömülü yazılım içeren yüksek teknoloji ürünleri de % 100 yerli olarak üretmeye başlamıştır.

Üretimini % 86' sını ihraç eden SERTPLAS, Türk tasarım ve mühendisliğini uluslararası arenada temsil etmektedir.

Tarihçe

SERTPLAS, 1955 yılında İstanbul'da kurucusu Hasan Serter tarafından küçük bir enjeksiyon atölyesi olarak iş dünyasına adım attı. Bugün ise, 40.000 m² arazi üzerinde 11.500 m² kapalı alan altında 325 çalışanı ile otomotiv yedek parça sektörüne hizmet vermektedir.

Ağırlıklı olarak kamyon ve treylerler için aydınlatma ve sinyalizasyon parçaları, elektrik/elektronik sistemler, elektrik kabloları, konnektörler, araç gövde parçaları, çamurluklar, hava hortumları, fren hava kaplinleri, konvertör ve regülatör gibi ürünlerin üretimini gerçekleştirmektedir.

Pazardaki değişim ve gereksinimlere verilen önem sayesinde, bugün üretimini % 86'sını Avrupa, Afrika, Orta Doğu, Asya, Güney Amerika dahilinde 60'a yakın ülkeye, aynı zamanda da OE üreticilerine ihraç etmekten gurur duymaktadır.

Tasarımdan seri üretime, SERTPLAS dünya çapında bir çok müşterisi tarafından tercih edilen çözüm partneri olarak tedarikçi listelerinde yer almaktadır.

Vizyonumuz

Elektrikli otomobil ve ağır vasıta tedarik sektöründe SERTPLAS markasını yüksek teknoloji ürünler üreten lider tedarikçi markalardan biri haline getirmek.

Misyonumuz

- ❖ Kaliteden ödün vermeden, en son teknoloji üretim teknik ve teknolojilerini kullanarak müşteri memnuniyetini en üst seviyede tutmak.
- ❖ Geleceği yeniden tanımlayan Araştırma ve Geliştirme projelerine yatırım yaparak hizmet verdiğimiz sektörlere yüksek teknoloji ürünlerimizi sunmak.
- ❖ Şirket bünyesindeki uzmanlıklarımızı sürekli geliştirerek müşterilerimizin gelecekte karşılaştıkları problemlere şimdiden çözümler üreten ürünler tasarlamak.
- ❖ İş arkadaşlarımızın kendilerini sürekli geliştirebileceği bir ortam yaratarak ortak değerimiz olan SERTPLAS firmasını ileriye taşımalarına destek olmak.

ADR CERTIFICATIONS

TÜV SÜD Auto Service GmbH Westendstrasse 199 D-80686 München	 Auto Service
Prüfbericht-Nr. / Test-Report-No.: 16-00313-CC-GBM Nachtrag 03 Hersteller / manufacturer: SERTPLAS OTO YAN SAN VE TIC.A.S., Silivri-Istanbul (Turkey) Typ / type: ADR – FLRYYY – PVC cable	Seite / page 1 von / of 6
TÜV SÜD Auto Service GmbH Westendstrasse 199 D-80686 München	 Auto Service
Prüfbericht-Nr. / Test-Report-No.: 16-00314-CC-GBM Nachtrag 02 Hersteller / manufacturer: SERTPLAS OTO YAN SAN VE TIC.A.S., Silivri-Istanbul (Turkey) Typ / type: ADR – FLRYLTY – THU cable	Seite / page 1 von / of 6
TÜV SÜD Auto Service GmbH Westendstrasse 199 D-80686 München	 Auto Service
Prüfbericht-Nr. / Test-Report-No.: 16-00315-CC-GBM Nachtrag 02 Hersteller / manufacturer: SERTPLAS OTO YAN SAN VE TIC.A.S., Silivri-Istanbul (Turkey) Typ / type: ADR – FLRYWIZY – TPE cable	Seite / page 1 von / of 6
TÜV SÜD Auto Service GmbH Westendstrasse 199 D-80686 München	 Auto Service
Prüfbericht-Nr. / Test-Report-No.: 16-00316-CC-GBM Nachtrag 03 Hersteller / manufacturer: SERTPLAS OTO YAN SAN VE TIC.A.S., Silivri-Istanbul (Turkey) Typ / type: ADR – FLRYYY – PVC cable	Seite / page 1 von / of 6
TÜV SÜD Auto Service GmbH Westendstrasse 199 D-80686 München	 Auto Service
Prüfbericht-Nr. / Test-Report-No.: 17-00305-CC-GBM-02 Hersteller / manufacturer: SERTPLAS OTO YAN SAN VE TIC.A.S., Silivri-Istanbul (Turkey) Typ / type: ADR – TSP 6-series	Seite / page 1 von / of 5
TÜV SÜD Auto Service GmbH Westendstrasse 199 D-80686 München	 Auto Service
Prüfbericht-Nr. / Test-Report-No.: 17-00306-CC-GBM extension 02 Hersteller / manufacturer: SERTPLAS OTO YAN SAN VE TIC.A.S., Silivri-Istanbul (Turkey) Typ / type: ADR – ABS655 6-series	Seite / page 1 von / of 6
TÜV SÜD Auto Service GmbH Westendstrasse 199 D-80686 München	 Auto Service
Prüfbericht-Nr. / Test-Report-No.: 17-00307-CC-GBM-00 Hersteller / manufacturer: SERTPLAS OTO YAN SAN VE TIC.A.S., Silivri-Istanbul (Turkey) Typ / type: ADR – coiled cable E42 series	Seite / page 1 von / of 6

Prüfbericht / Test-Report

Beurteilung einer Anschlussverbindung mit den Anforderungen des ADR /
 Approval of an electrical connection in accordance with the requirements of ADR

Name und Anschrift des Prüflaboratoriums / Name and address of the Test Laboratory: TÜV SÜD Auto Service GmbH, Daimlerstraße 13, D-85748 Garching	
Name und Anschrift des Auftraggebers / Name and address of orderer:	SERTPLAS OTO YAN SAN VE TIC.A.S., Laleli Cad. Hanger Sok. No:16 34570 Büyükdere, Silivri-Istanbul, Turkey

1. Vorgang

Eine gewendelte elektrische Anhänger-Verbindungsleitung, vorgesehen für den Einsatz in bestimmten Beförderungseinheiten zur Beförderung gefährlicher Güter, soll auf Übereinstimmung mit den Anforderungen des ADR

1. Process

A coiled electrical connection cable to the trailer due to use in special transport units for the carriage of dangerous goods should be approved on the requirements of ADR

TÜV SÜD Auto Service GmbH Westendstrasse 199 D-80686 München	 Auto Service
Prüfbericht-Nr. / Test-Report-No.: 16-00213-CC-GBM extension 01 Hersteller / Manufacturer: SERTPLAS OTO YAN SAN VE TIC.A.S., Silivri-Istanbul, Turkey Typ / Type: ADR Light Set	Seite / page 1 von / of 13
TÜV SÜD Auto Service GmbH Westendstrasse 199 D-80686 München	 Auto Service
Prüfbericht-Nr. / Test-Report-No.: 16-00215-CC-GBM extension 01 Hersteller / Manufacturer: SERTPLAS OTO YAN SAN VE TIC.A.S., Silivri-Istanbul (Turkey) Typ / Type: ADR – 3XF rear LED lamp 0316L Series	ADR Seite / page 1 von / of 6
TÜV SÜD Auto Service GmbH Westendstrasse 199 D-80686 München	 Auto Service
Prüfbericht-Nr. / Test-Report-No.: 16-00216-CC-GBM extension 01 Hersteller / Manufacturer: SERTPLAS OTO YAN SAN VE TIC.A.S., Silivri-Istanbul (Turkey) Typ / Type: ADR – 3XF rear LED lamp 0355L Series	ADR Seite / page 1 von / of 6
TÜV SÜD Auto Service GmbH Westendstrasse 199 D-80686 München	 Auto Service
Prüfbericht-Nr. / Test-Report-No.: 16-00207-CC-GBM-01 Hersteller / manufacturer: SERTPLAS OTO YAN SAN VE TIC.A.S., Silivri-Istanbul (Turkey) Typ / type: ADR – FLRY – single PVC cable class A	Seite / page 1 von / of 6
TÜV SÜD Auto Service GmbH Westendstrasse 199 D-80686 München	 Auto Service
Prüfbericht-Nr. / Test-Report-No.: 16-00296-CC-GBM-01 Hersteller / manufacturer: SERTPLAS OTO YAN SAN VE TIC.A.S., Silivri-Istanbul (Turkey) Typ / type: ADR – FLRY – single PVC cable class C	Seite / page 1 von / of 6
TÜV SÜD Auto Service GmbH Westendstrasse 199 D-80686 München	 Auto Service
Prüfbericht-Nr. / Test-Report-No.: 16-00209-CC-GBM-01 Hersteller / manufacturer: SERTPLAS OTO YAN SAN VE TIC.A.S., Silivri-Istanbul (Turkey) Typ / type: ADR – FLRY 3in – single PVC cable class A	Seite / page 1 von / of 6
TÜV SÜD Auto Service GmbH Westendstrasse 199 D-80686 München	 Auto Service
Prüfbericht-Nr. / Test-Report-No.: 16-00300-CC-GBM-01 Hersteller / manufacturer: SERTPLAS OTO YAN SAN VE TIC.A.S., Silivri-Istanbul (Turkey) Typ / type: ADR – FLRY 3in – single PVC cable class C	Seite / page 1 von / of 6

Prüfbericht / Test-Report

Beurteilung einer elektrischen Einzelleitung auf Übereinstimmung mit den Anforderungen des ADR /
 Approval of an electrical single cable in accordance with the requirements of ADR

Name und Anschrift des Prüflaboratoriums / Name and address of the Test Laboratory: TÜV SÜD Auto Service GmbH, Daimlerstraße 13, D-85748 Garching	
Name und Anschrift des Auftraggebers / Name and address of orderer:	SERTPLAS OTO YAN SAN VE TIC.A.S., Laleli Cad. Hanger Sok. No:16 34570 Büyükdere, Silivri-Istanbul, Turkey

1. Vorgang

Eine gewendelte elektrische Einzelleitung, vorgesehen für den Einsatz in bestimmten Beförderungseinheiten zur Beförderung gefährlicher Güter, soll auf Übereinstimmung mit den Anforderungen des ADR

1. Process

A coiled electrical connection cable to the trailer due to use in special transport units for the carriage of dangerous goods should be approved on the requirements of ADR

ISO CERTIFICATION



Certificate of Registration

This certificate has been awarded to

SERTPLAS OTO YAN. SAN. VE TİC. A.Ş.

Laiklik Cad. Hançer Sok. No:16 34570 Büyükkılıçlı Mah. Silivri İSTANBUL, Turkey

in recognition of the organization's Quality Management System which complies with

ISO 9001:2015

The scope of activities covered by this certificate is defined below

Please refer to the Appendix

Certificate Number 75141/B/0002/UK/EN			
Date of Issue of Certification Cycle	Issue Number	Certificate Expiry Date	Certification Cycle
22 June 2022	5	21 June 2025	2
Revision Date	Revision Number	Original Certificate Issue Date	Scheme Number
14 March 2022	8	22 June 2018	n/a

For detailed explanation for the data fields above, refer to <http://www.urs-holdings.com/logos-and-regulations>

Issued by



On behalf of the Schemes Manager



ISO CERTIFICATION



Appendix to Certificate

Foreign Trade, Customs Clearance, Management and Administrative Organization Activities and Operations Associated with these Activities and Production and Delivery of Services Related to these Activities of Design and Manufacture of Automotive; Lighting Systems, Electrical Systems, Pneumatic Systems, Air Brake Systems, Body Parts, Marine; Cables and Lightings

Certificate Number 75141/B/0002/UK/En			
Date of Issue of Certification Cycle	Issue Number	Certificate Expiry Date	Certification Cycle
22 June 2022	5	21 June 2025	2
Revision Date	Revision Number	Original Certificate Issue Date	Scheme Number
14 March 2022	0	22 June 2018	n/a

For detailed explanation for the data fields above, refer to <http://www.urs-holdings.com/logos-and-regulations>

Issued by



On behalf of the Schemes Manager



ISO CERTIFICATION



Certificate of Registration

This certificate has been awarded to

SERTPLAS OTO YAN. SAN. VE TİC. A.Ş.

Laiklik Cad. Hançer Sok. No:16 34570 Büyükkılıçlı Mahallesi Silivri İSTANBUL, Turkey

In recognition of the organization's Quality Management System which complies with

IATF 16949:2016

The scope of activities covered by this certificate is defined below

Manufacture of Lighting Systems, Electrical Systems, Pneumatic Systems and Air Brake Systems (Excludes Product Design under Clause 8.3)

Certificate Number 75141/B/0001/SM/En			
Date of Issue of Certification Cycle	Issue Number	Certificate Expiry Date	Certification Cycle
11 May 2021	2	11 May 2024	2
Revision Date	Revision Number	Original Certificate Issue Date	Scheme Number
11 May 2021	0	04 June 2018	0399471

For detailed explanation for the data fields above, refer to <http://www.urs-holdings.com/logo-and-regulations>

Issued by



On behalf of the Schemes Manager



ISO CERTIFICATION



Certificate of Registration

This certificate has been awarded to

SERTPLAS OTO YAN. SAN. VE TİC. A.Ş.

Laiklik Cad. Hançer Sok. No:16 34570 Büyükkalıcı Mah. Silivri İSTANBUL, Turkey

In recognition of the organization's Environmental Management System which complies with

ISO 14001:2015

The scope of activities covered by this certificate is defined below

Please refer to the Appendix

Certificate Number 75141/A/0002/UK/En			
Date of Issue of Certification Cycle	Issue Number	Certificate Expiry Date	Certification Cycle
27 April 2022	5	26 April 2025	3
Revision Date	Revision Number	Original Certificate Issue Date	Scheme Number
14 March 2022	0	27 April 2016	n/a

For detailed explanation for the data fields above, refer to <http://www.urs-holdings.com/igov-and-regulations>

Issued by



On behalf of the Schemes Manager



ISO CERTIFICATION



Certificate of Registration

This certificate has been awarded to

SERTPLAS OTO YAN. SAN. VE TİC. A.Ş.

Laiklik Cad. Hançer Sok. No:16 34570 Büyükkılıçlı Mahallesi Silivri İSTANBUL, Turkey

In recognition of the organization's information Security Management System which complies with

ISO 27001:2013

The scope of activities covered by this certificate is defined below

PROTECTING ASSETS USED FOR AUTOMOTIVE LIGHTING SYSTEMS, ELECTRIC SYSTEMS, PNEUMATIC SYSTEMS, AIR BRAKE SYSTEMS AND BODY PARTS PRODUCTION AND DESIGN, FOREIGN TRADE, LOGISTICS, STORAGE, ACCOUNTING AND FINANCE. SOA 29.12.20 Rev.3

Certificate Number: 75141/C/0001/UK/En

Date of Issue of Certification Cycle	Issue Number	Certificate Expiry Date	Certification Cycle
08 March 2022	2	07 March 2025	2
Revision Date	Revision Number	Original Certificate Issue Date	Scheme Number
29 December 2021	0	08 March 2019	n/a

For detailed explanation for the data fields above, refer to <http://www.urs-holdings.com/logos-and-regulations>

Issued by



On behalf of the Schemes Manager



Please do not alter the validity of this certificate, please do not delete or contact the issuer (URS) of the scope or change the details of the certificate. URS is a member of United Registrar of Systems (URS) Ltd, United Kingdom, 4 Church Lane, Brentwood, Essex, UK. URS is registered in England.

Contents

	Page
TRAILER PARTS	1-63
COMPLETE LIGHTING SETS FOR TRAILER (DORSET)	1-19
Spare Parts For Complete Lighting Sets	20-22
LIGHTING	21-52
Tail Lamps	23-35
Marker & Position Lamps	36-48
Indoor Ceiling Lamps	49-50
Number Plate Lamps	50
Reflectors	51-52
AIR PRESSURE AND BRAKING PARTS FOR TRAILER	53-54
MULTI CORE CABLES	55
AIR BRAKE CONNECTION FITTINGS FOR TRAILER	56-57
EQUIPMENTS & ACCESSORIES FOR TRAILER	58-63
TRUCK PARTS	64-144
ELECTRICAL COILS, PLUGS & SOCKETS FOR TRUCK	64-96
AIR PRESSURE AND BRAKING PARTS FOR TRUCK	97-98
AIR BRAKE CONNECTION FITTINGS FOR TRUCK	99
TAIL LAMPS FOR TRUCK	100-121
OFF ROAD VEHICLES LIGHTING SETS	103
MRC TRUCK LIGHTING	122-128
MUDGUARDS & BODY PARTS FOR TRUCK	129-132
ROTATING BEACONS	133-135
WORKING LIGHT FOR TRUCK	136-137
TRUCK EQUIPMENTS & ACCESSORIES	138-141
GENERAL ELECTRICAL PARTS	142-144
COMMERCIAL VEHICLE LIGHTING	145-150

İçindekiler

Sayfa

DORSE YEDEK PARÇALARI	1-63
TIR DORSELERİ İÇİN KOMPLE AYDINLATMA SETLERİ	1-19
Aydınlatma Seti Parçaları	20-22
AYDINLATMA PARÇALARI	21-52
Arka İşaret Lambaları	23-35
İşaret & Pozisyon Lambaları	36-48
İç Aydınlatma Lambaları	49-50
Plaka Aydınlatma Lambaları	50
Reflektörler	51-52
TIR DORSELERİ İÇİN HAVA VE FREN PARÇALARI	53-54
ÇOK DAMARLI KABLOLAR	55
TIR DORSELERİ İÇİN FREN BAĞLANTI (FITTINGS) PARÇALARI	56-57
TIR DORSELERİ İÇİN EKİPMAN VE AKSESUARLAR	58-63
TIR ÇEKİCİ YEDEK PARÇALARI	64-144
TIR ÇEKİCİLER İÇİN ELEKTRİK BAĞLANTI KABLOLARI, FİŞLER VE SOKETLER	64-96
TIR ÇEKİCİLER İÇİN HAVA VE FREN PARÇALARI	97-98
TIR ÇEKİCİLER İÇİN FREN BAĞLANTI PARÇALARI	99
TIR ÇEKİCİLER İÇİN ARKA İŞARET LAMBALARI	100-121
OFF - ROAD ARAÇ AYDINLATMA SETİ	103
MRC TIR ÇEKİCİ AYDINLATMA PARÇALARI	122-128
TIR ÇEKİCİLER İÇİN ÇAMURLUK VE GÖVDE PARÇALARI	129-132
DÖNER LAMBALAR	133-135
TIR ÇEKİCİLER İÇİN ÇALIŞMA LAMBALARI	136-137
TIR ÇEKİCİLER İÇİN EKİPMAN VE AKSESUARLAR	138-141
TIR ÇEKİCİLER İÇİN GENEL ELEKTRİK PARÇALARI	142-144
TİCARİ ARAÇ AYDINLATMA PARÇALARI	145-150

Part number:	EVP.10.1.6.1
Rated current:	default (10A) max (16A)
Rated voltage:	230V AC
Rated frequency:	50 / 60Hz
Rated op. residual current AC:	30mA AC
Rated op. residual current DC:	6mA DC
IP Protection degree:	IP69 (Charge Control Box) IP44 (Cable and Vehicle connector)
Charging device dimensions:	8.7 cm x 27 cm x 5.2 cm
Product Weight:	1.96 kg
Operating temperature:	-25°C to + 50°C
Storing temperature:	-30°C to + 70°C
Humidity:	Up to 95%, non-condensation

+50°C -25°C

Charging time
16A: 8-10 hours*
10A: 10-12 hours*



Max. Current
Capacity
16 A



VoltiGo

PortableEV-ChargingDevice

Part number	Charge Plug Type	Regional Charging Current Limit	Countries	Compliance
EVP.10.1.6.1	Type 2	10 A	Europe (Turkey, Germany, France...)	CE
EVP.08.1.6.1	Type 2	8 A	Finland	CE
EVP.10.1.6.1	Type 2	10 A	UK, Ireland, Malta	CE
EVP.06.1.6.1	Type 2	6 A	Denmark	CE
EVP.08.1.6.1	Type 2	8 A	Switzerland	CE
EVP.10.1.6.1	Type 2	10 A	Norway	CE

* Pazarla göre ürünlerin akım sınırları kanunlarca belirlenmiştir. Lütfen sipariş verirken ürünün kullanılacağı ülkeyi satış birimimiz ile paylaşarak doğru ürünü seçtiğinizden emin olunuz.

* Rated output currents are regulated in different countries. Please state the intended country of use for your purchase to our sales team in order to select the compliant product for your region.

Part number:	EVW.32.1.5.1.R
Connection type:	1 phase (L-N-PE)
Rated power:	7.4kW
Rated current:	32A
Rated voltage:	230V AC
Rated frequency:	50 / 60Hz
Rated op. residual current AC:	30mA AC
Rated op. residual current DC:	6mA DC
IP Protection degree:	IP 54
Charging device dimensions:	18.8 cm x 35.5 cm x 12.7 cm
Product Weight:	4.49 kg
Operating temperature:	-25°C to + 50°C
Storing temperature:	-30°C to + 70°C
Humidity:	Up to 95%, non-condensation

Charging time
1 phase: 4-6 hours*
3 phase: 1-2 hours*



Adjustable Power

+50°C -25°C



Max. Current
Capacity
32 A

VoltiHome

EV-ChargingDevice
Single Phase



Part number:	EVW.32.3.5.1.R
Connection type:	3 phase (L1-L2-L3-N-PE)
Rated power:	22kW
Rated current:	32A
Rated voltage:	380V AC
Rated frequency:	50 / 60Hz
Rated op. residual current AC:	30mA AC
Rated op. residual current DC:	6mA DC
IP Protection degree:	IP 54
Charging device dimensions:	27 cm x 43.5 cm x 14.3 cm
Product Weight:	3 kg
Operating temperature:	-25°C to + 50°C
Storing temperature:	-30°C to + 70°C
Humidity:	Up to 95%, non-condensation

Charging time
1 phase: 4-6 hours*
3 phase: 1-2 hours*



Adjustable Power

+50°C -25°C



Max. Current
Capacity
32 A

VoltiHome

EV-ChargingDevice
Three Phase



*Şarj süreleri araçtan araca değişiklik gösterebilir. Hesaplamalar 22kW OBC ve 30kWh pil üzerinedir.

*Charging times may vary. Values calculated with a 22kW on-board charging system (OBC) and a 30kWh battery capacity.



VoltiStation

**EV-Charging Device
Single Phase**



Part number:	EVST.32.1.0.1.S
Connection type:	1 phase (L-N-PE)
Rated power:	7.4kW
Rated current:	32A
Rated voltage:	230V AC
Rated frequency:	50 / 60Hz
Rated op. residual current AC:	30mA AC
Rated op. residual current DC:	6mA DC
IP Protection degree:	IP 54
Charging device dimensions:	18.8 cm x 35.5 cm x 12.7 cm
Product Weight:	2.49 kg
Operating temperature:	-25°C to + 50°C
Storing temperature:	-30°C to + 70°C
Humidity:	Up to 95%, non-condensation

Charging time
1 phase: 4-6 hours*
3 phase: 1-2 hours*



Adjustable Power

+50°C -25°C



Max. Current
Capacity
32 A



VoltiStation

**EV-Charging Device
Three Phase**

Part number:	EVST.32.3.0.1.S
Connection type:	3 phase (L1-L2-L3-N-PE)
Rated power:	22kW
Rated current:	32A
Rated voltage:	380V AC
Rated frequency:	50 / 60Hz
Rated op. residual current AC:	30mA AC
Rated op. residual current DC:	6mA DC
IP Protection degree:	IP 54
Charging device dimensions:	27 cm x 43.5 cm x 14.3 cm
Product Weight:	3 kg
Operating temperature:	-25°C to + 50°C
Storing temperature:	-30°C to + 70°C
Humidity:	Up to 95%, non-condensation

Charging time
1 phase: 4-6 hours*
3 phase: 1-2 hours*



Adjustable Power

+50°C -25°C



Max. Current
Capacity
32 A



VoltiCable

EV-Charging Cable

Part number:	EVC.32.3.5.1	EVC.32.1.5.1
Rated current:	32A	32A
Rated voltage:	380V AC	230V AC
Rated frequency:	50 / 60Hz	
IP Protection degree:	IP 44 (Cable and Vehicle connector)	
Cable working length:	4 meter spiral	6 meter flat
Operating temperature:	-25°C to + 50°C	
Storing temperature:	-30°C to + 70°C	
Humidity:	Up to 95%, non-condensation	

+50°C -25°C



Max. Current
Capacity
32 A

*Düz şarj kablosu modellerimiz de mevcuttur.

*Straight cable models are also available for purchase.

*Şarj süreleri araçtan araca değişiklik gösterebilir. Hesaplamalar 22kW OBC ve 30kWh pil üzerinedir.

*Charging times may vary. Values calculated with a 22kW on-board charging system (OBC) and a 30kWh battery capacity.



ADR Certificated Complete Lighting Sets for Trailer (DORSET)
ADR Sertifikalı Komple Aydınlatma Seti (DORSET)



ADR LIGHT SET

D101Q137.ADR

Report No.
ADR1401001

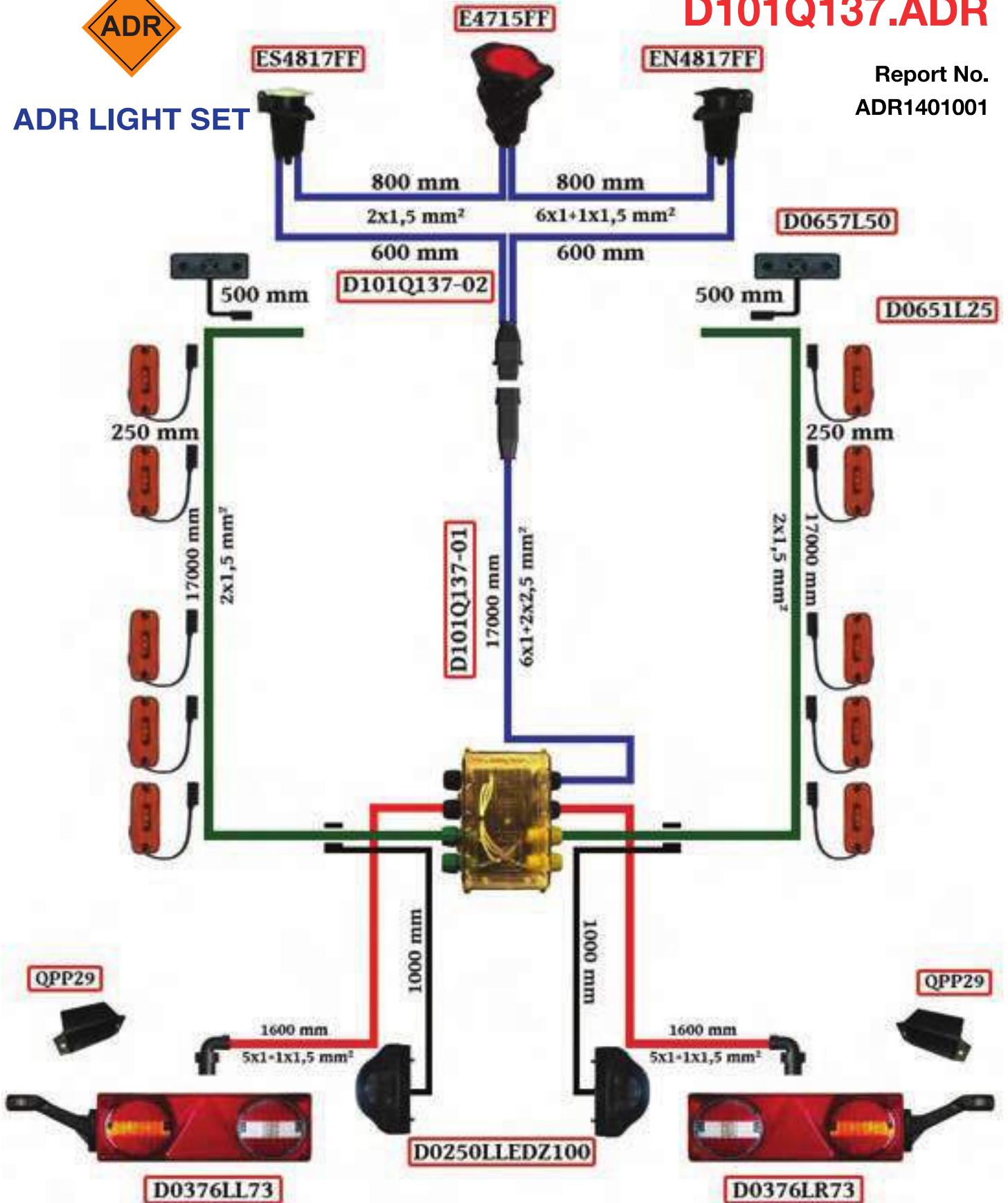

ADR Certificated Complete Lighting Sets for Trailer (DORSET)
ADR Sertifikalı Komple Aydınlatma Seti (DORSET)

D101Q138.ADR

Report No.
ADR1401001



ADR LIGHT SET

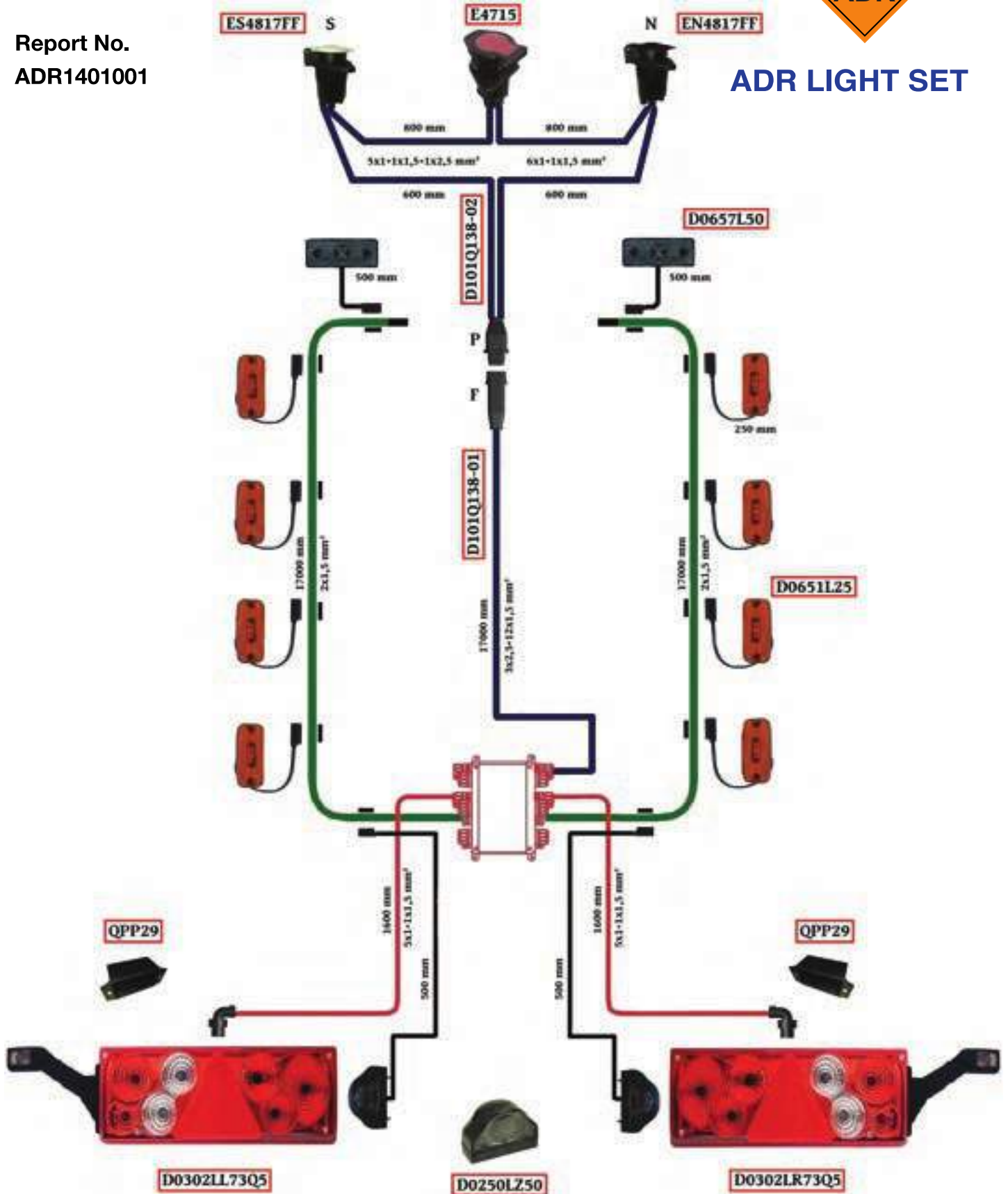

Complete Lighting Sets for Trailer (DORSET)
Komple Aydınlatma Seti (DORSET)

TRAIL-TECH

D100

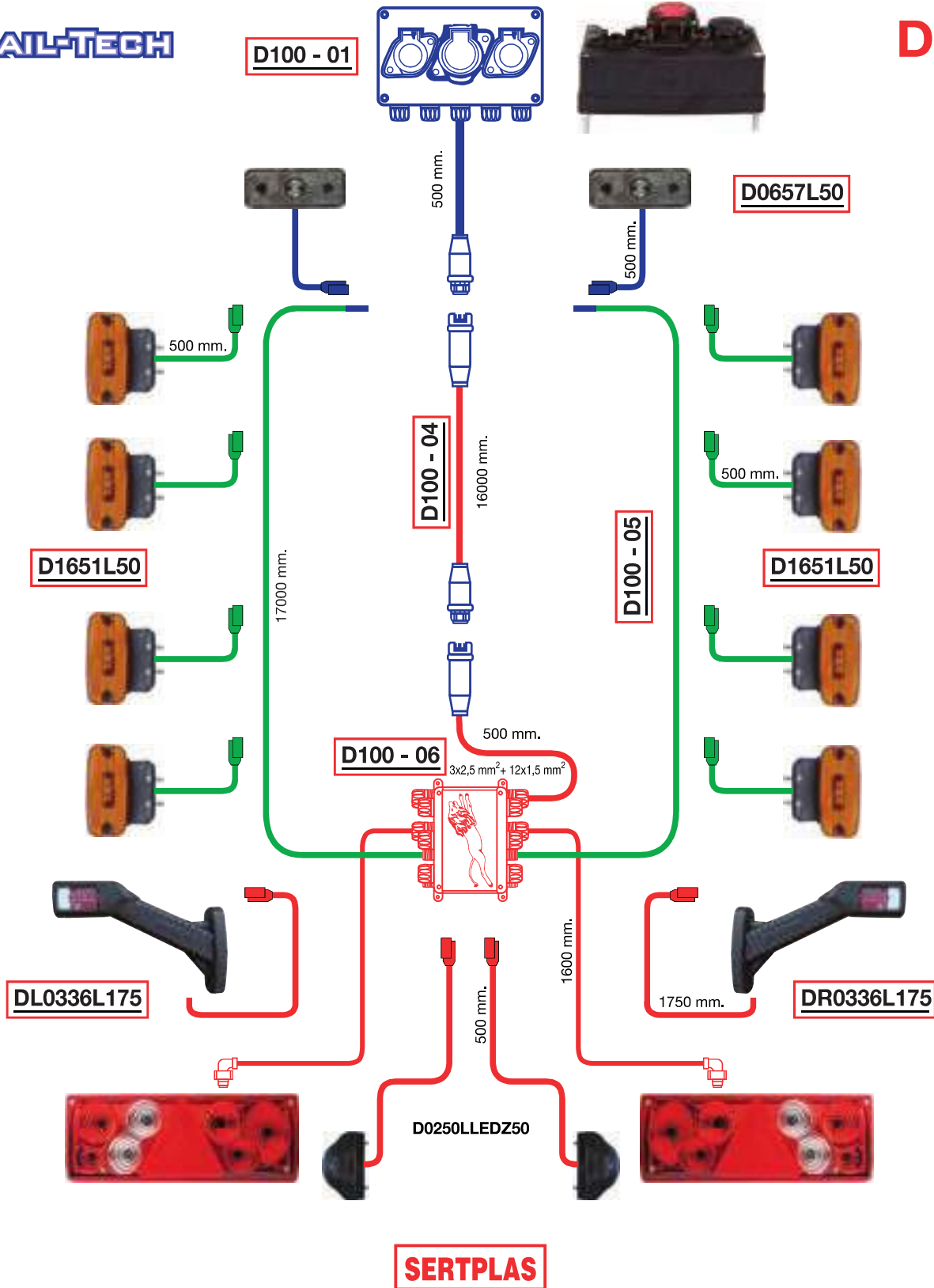

We would be pleased to supply DORSETs according to your special requirements.
(Özel isteklerinize uygun olarak dorset üretilebilir.)

Complete Lighting Sets for Trailer (DORSET)
Komple Aydınlatma Seti (DORSET)

TRAIL-TECH

D100Q9

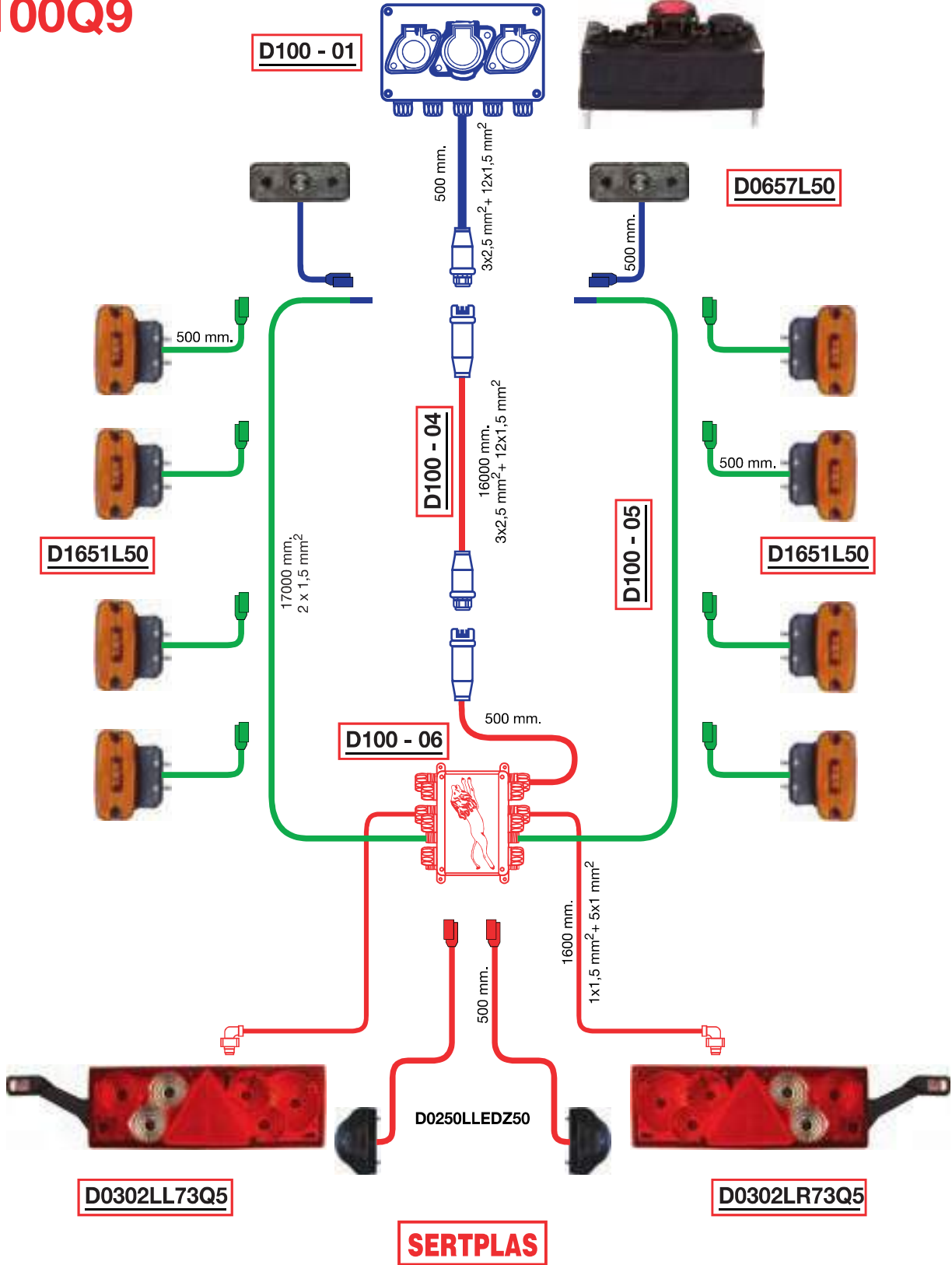

We would be pleased to supply DORSETs according to your special requirements.
(Özel isteklerinize uygun olarak dorset üretilebilir.)

Complete Lighting Sets for Trailer (DORSET)
Komple Aydınlatma Seti (DORSET)

D101Q112

TRAIL-TECH

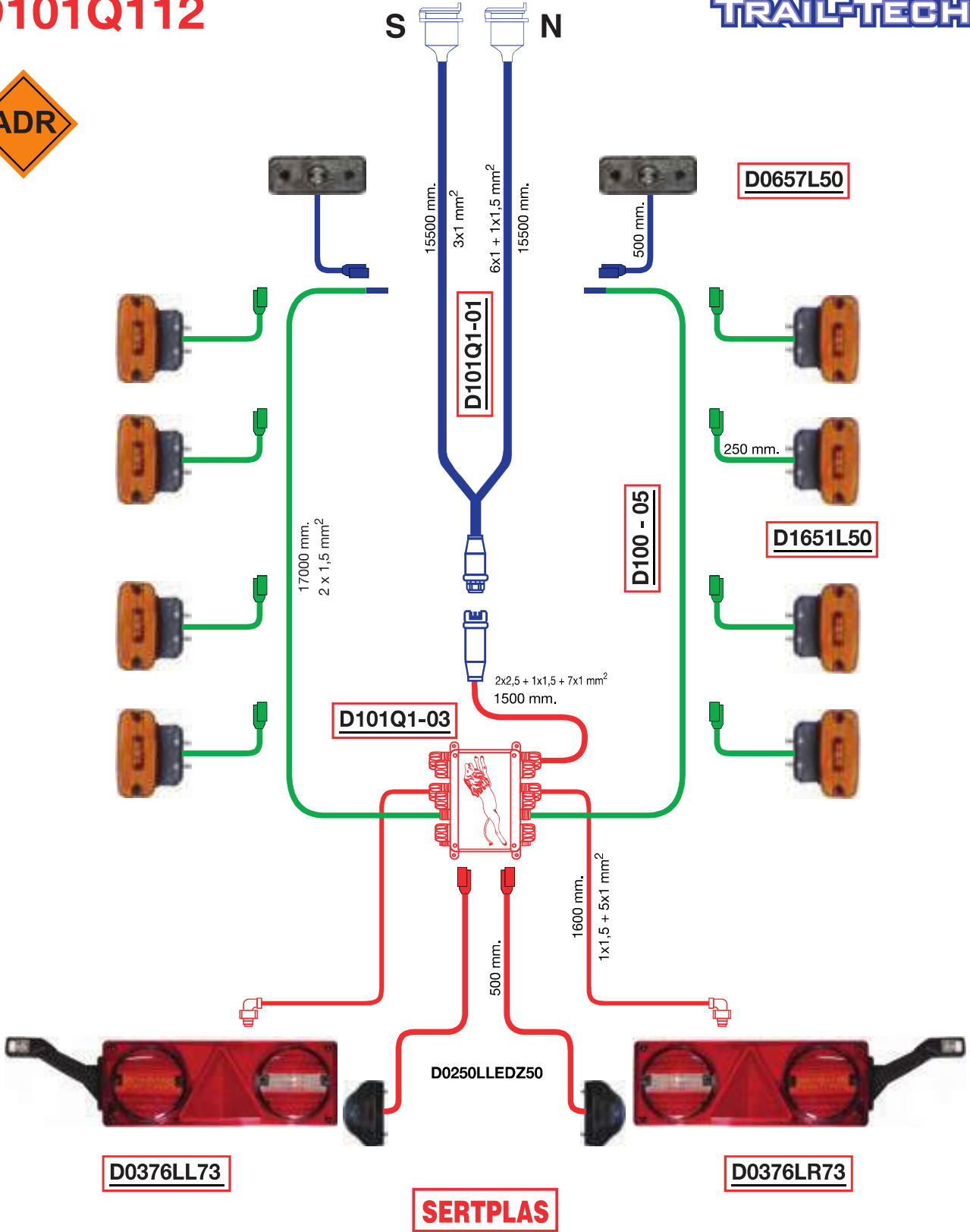

We would be pleased to supply DORSETs according to your special requirements.
(Özel isteklerinize uygun olarak dorset üretilebilir.)

Complete Lighting Sets for Trailer (DORSET)
Komple Aydınlatma Seti (DORSET)

TRAIL-TECH

D101Q118W

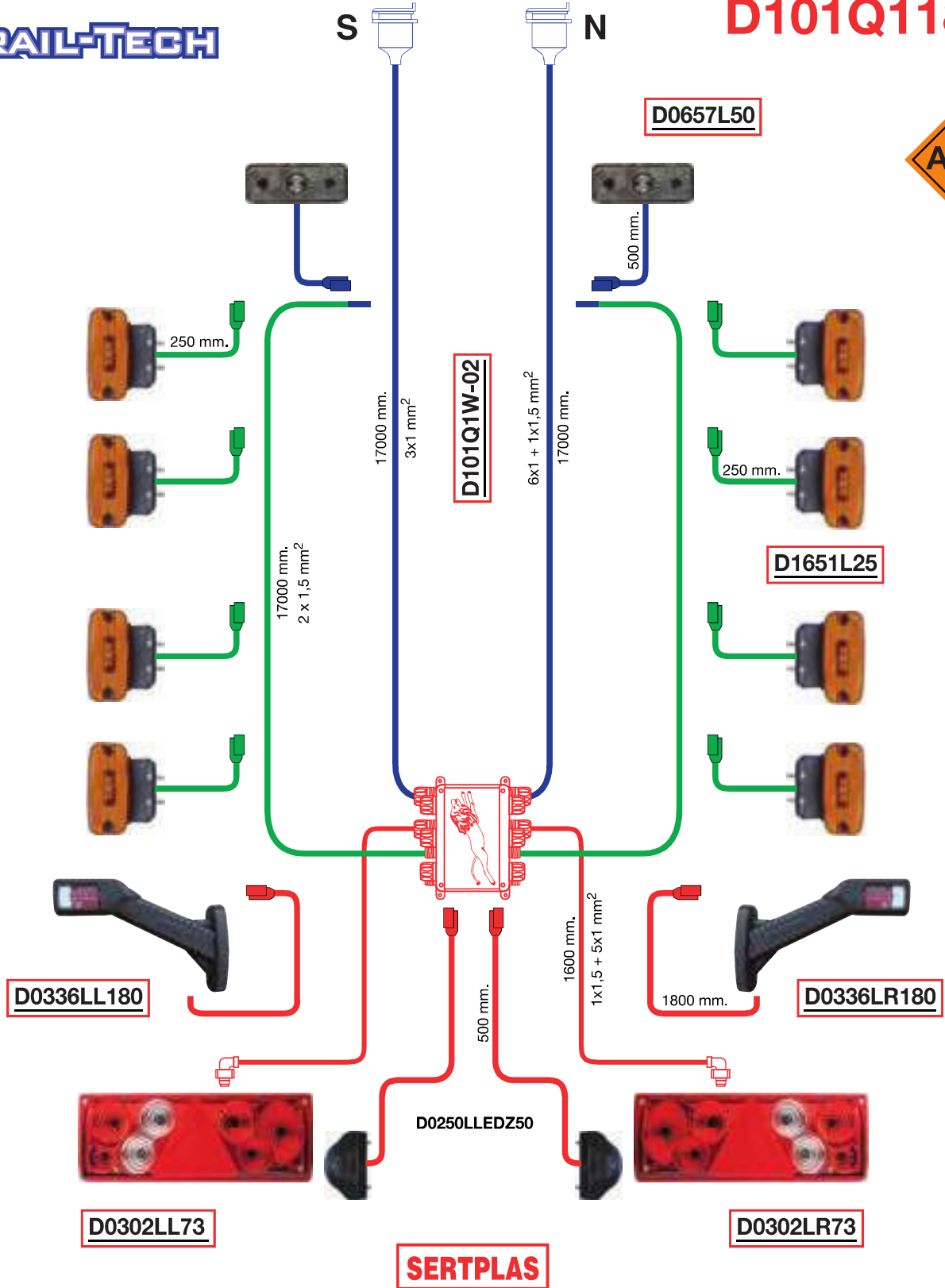

We would be pleased to supply DORSETs according to your special requirements.
(Özel isteklerinize uygun olarak dorset üretilebilir.)

Complete Lighting Sets for Trailer (DORSET)
Komple Aydınlatma Seti (DORSET)

D101Q1W

TRAIL-TECH

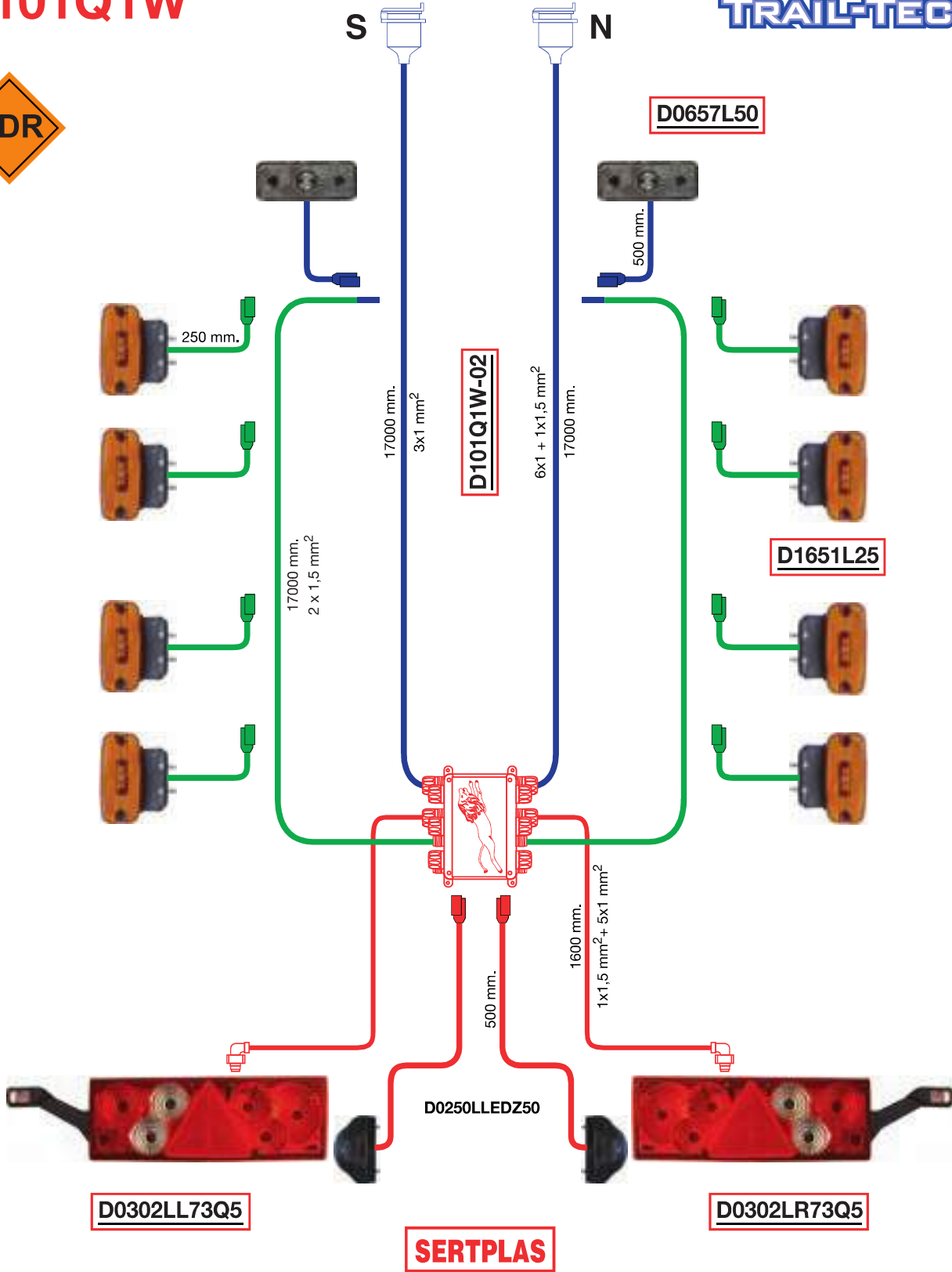

We would be pleased to supply DORSETs according to your special requirements.
(Özel isteklerinize uygun olarak dorset üretilebilir.)

Complete Lighting Sets for Trailer (DORSET)
Komple Aydınlatma Seti (DORSET)

TRAIL-TECH

D101Q7

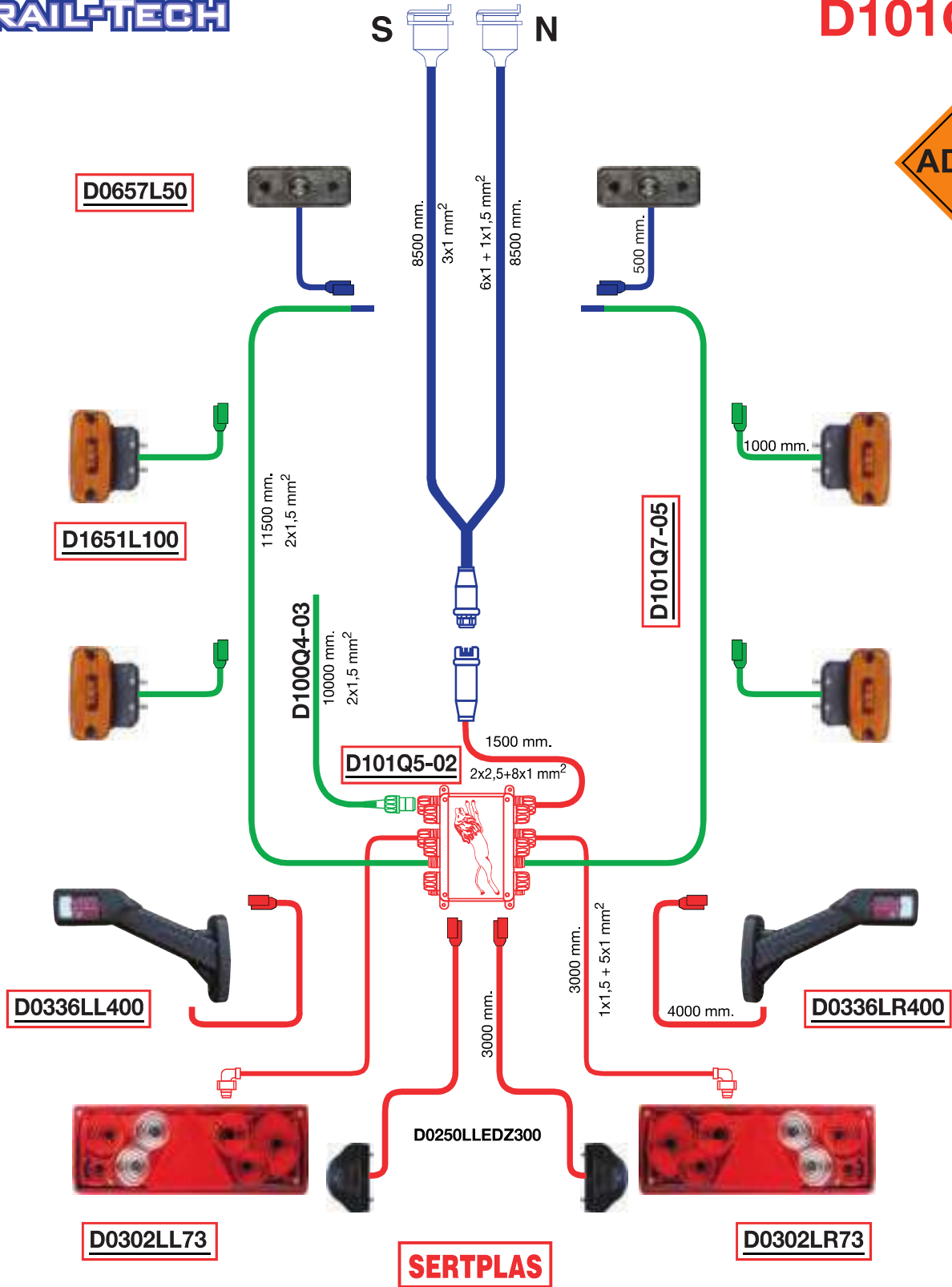

We would be pleased to supply DORSETs according to your special requirements.
(Özel isteklerinize uygun olarak dorset üretilebilir.)

Complete Lighting Sets for Trailer (DORSET)
Komple Aydınlatma Seti (DORSET)

D101Q125

TRAIL-TECH

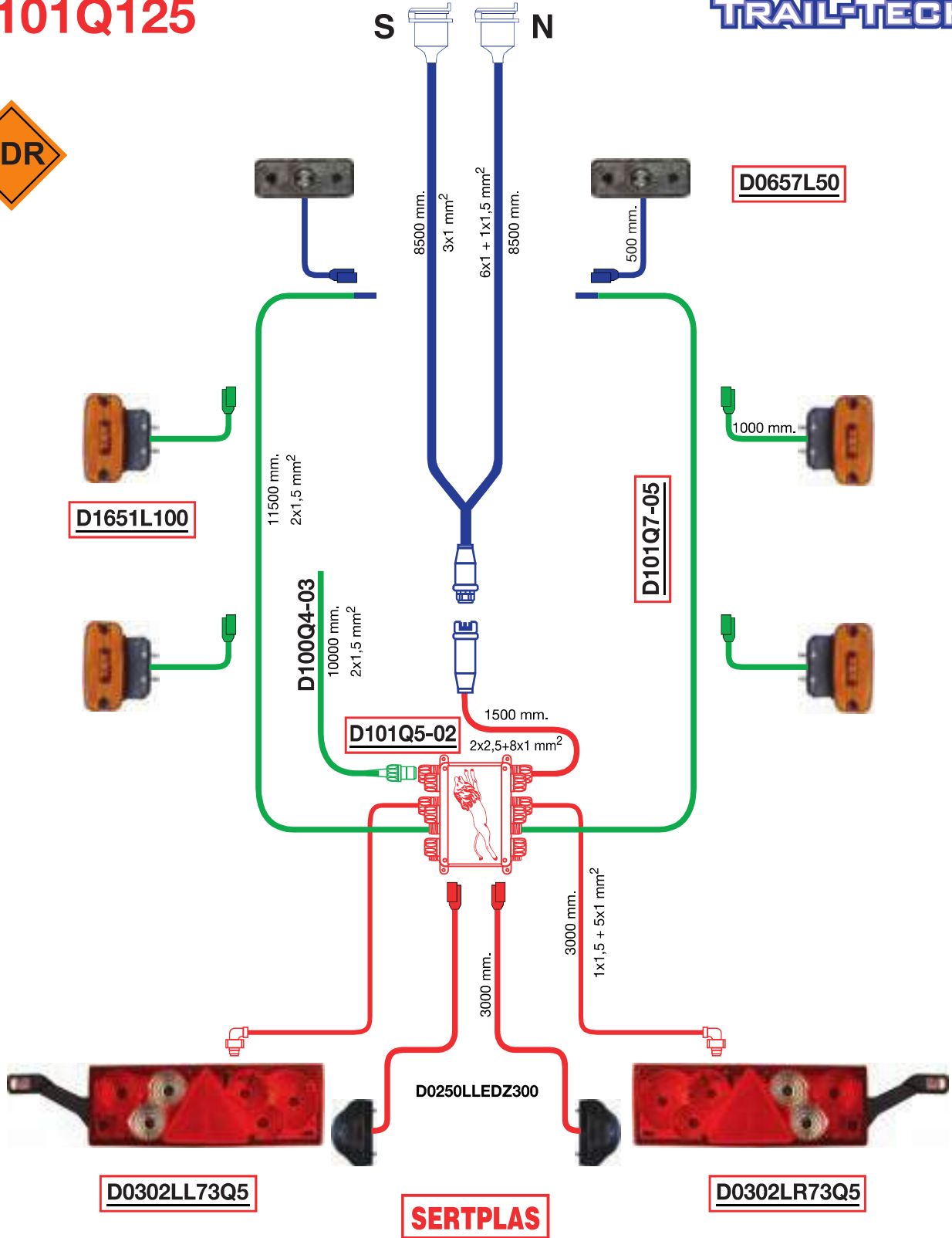

We would be pleased to supply DORSETs according to your special requirements.
(Özel isteklerinize uygun olarak dorset üretilebilir.)

Complete Lighting Sets for Trailer (DORSET)
Komple Aydınlatma Seti (DORSET)

TRAIL-TECH

D101Q132W

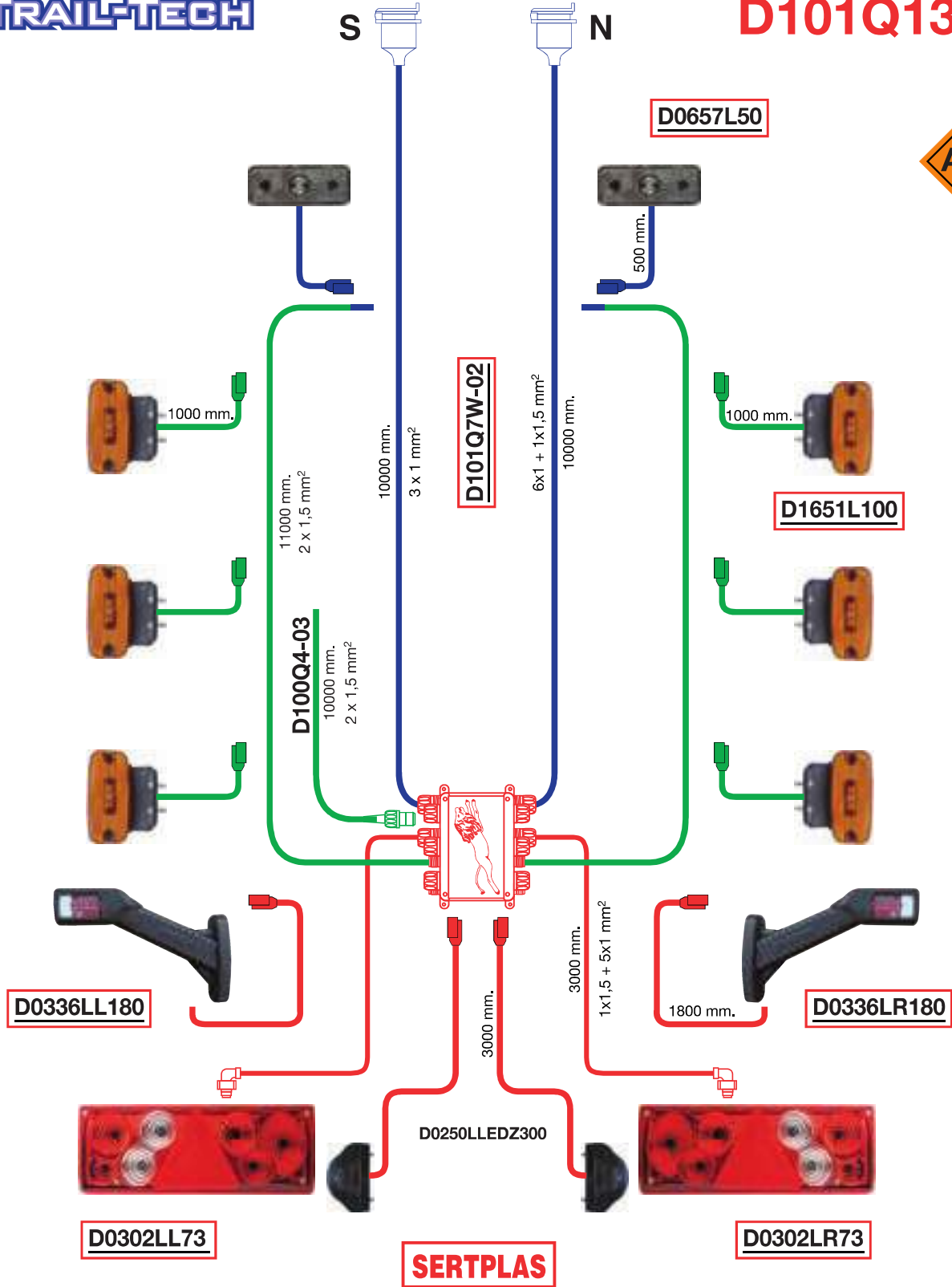

We would be pleased to supply DORSETs according to your special requirements.
(Özel isteklerinize uygun olarak dorset üretilebilir.)

Complete Lighting Sets for Trailer (DORSET)
Komple Aydınlatma Seti (DORSET)

D101Q7W



TRAIL-TECH

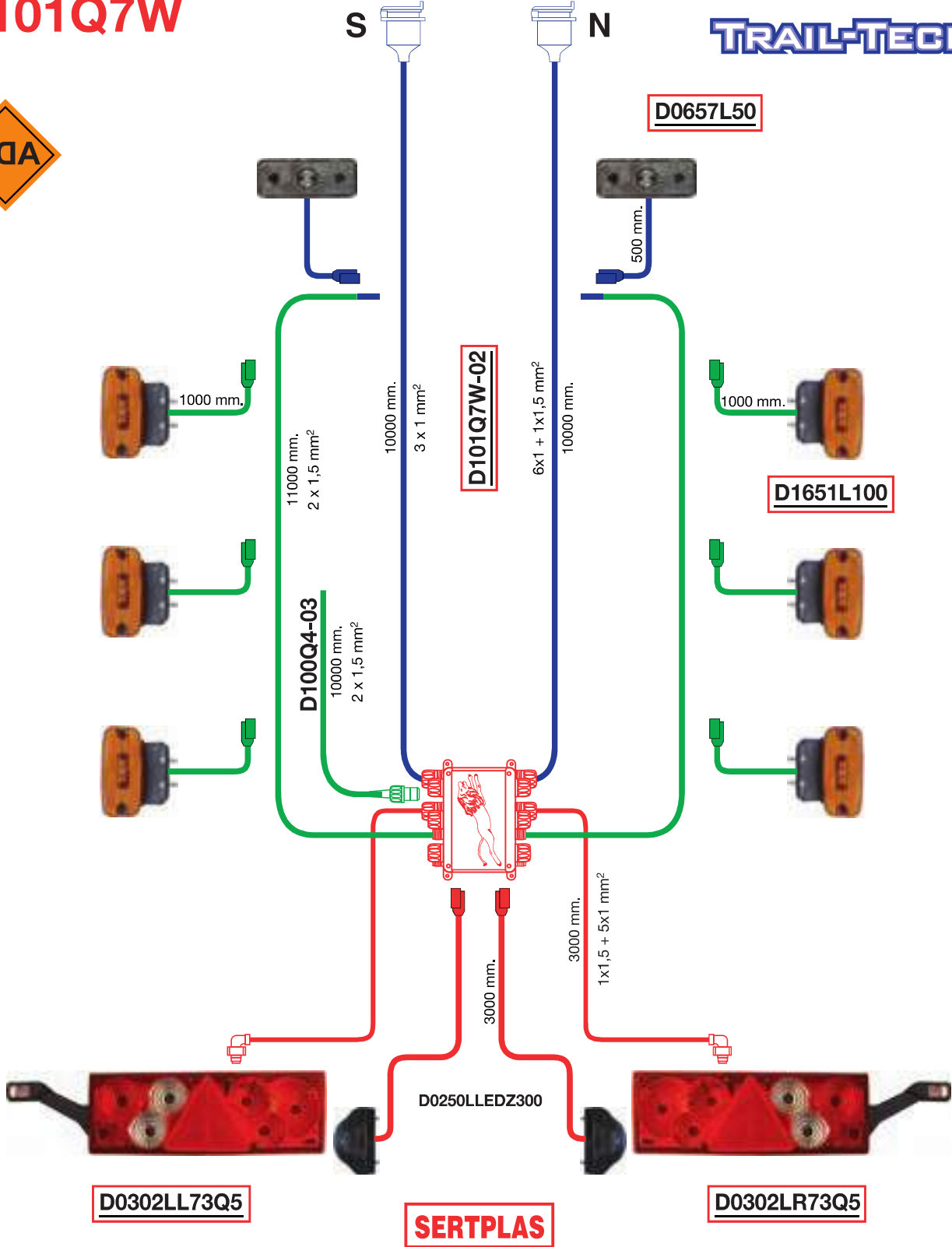

We would be pleased to supply DORSETs according to your special requirements.
(Özel isteklerinize uygun olarak dorset üretilebilir.)

Complete Lighting Sets for Trailer (DORSET)
Komple Aydınlatma Seti (DORSET)

TRAIL-TECH

D105

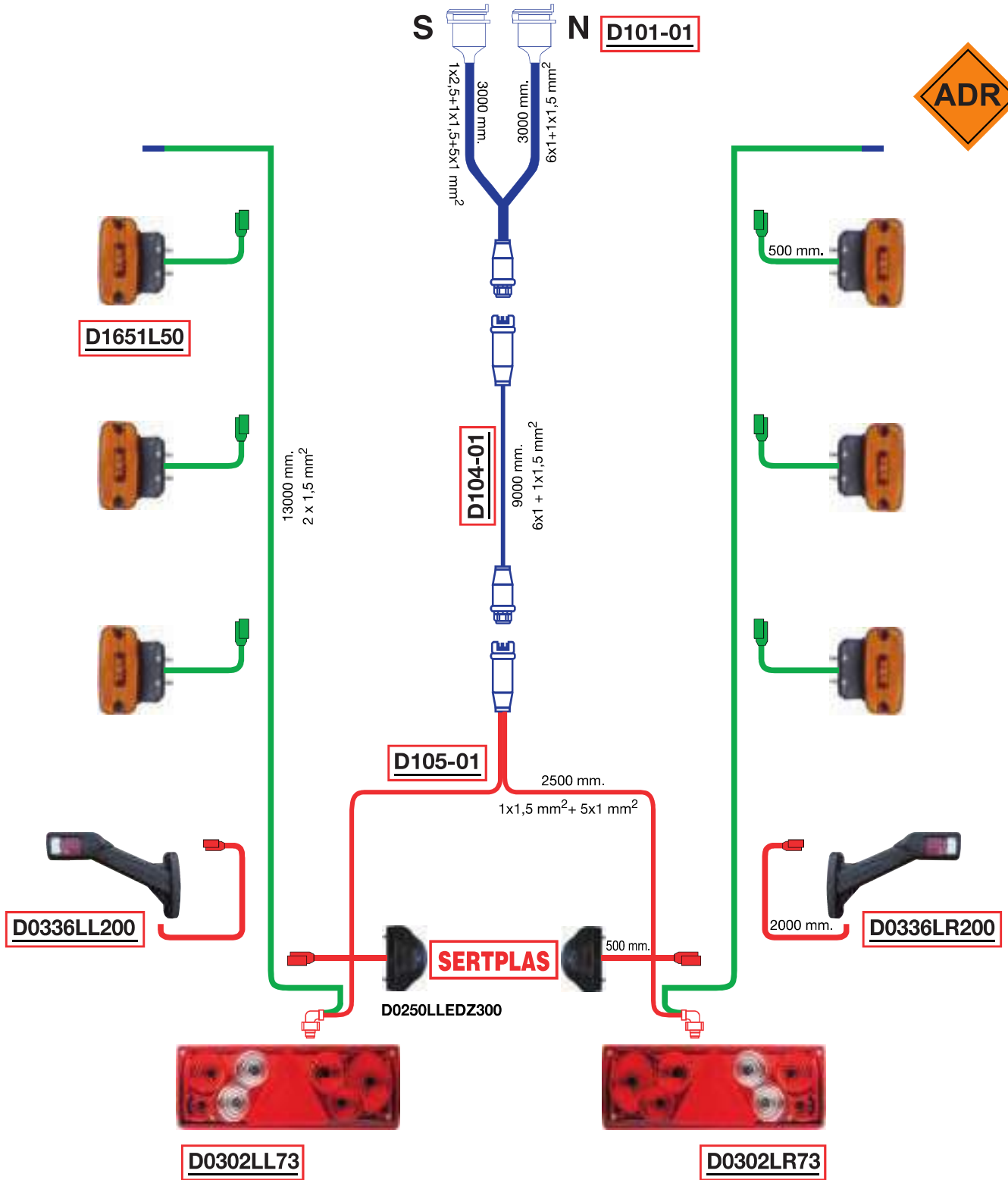

We would be pleased to supply DORSETs according to your special requirements.
(Özel isteklerinize uygun olarak dorset üretilebilir.)

Complete Lighting Sets for Trailer (DORSET)
Komple Aydınlatma Seti (DORSET)

D105Q116

TRAIL-TECH

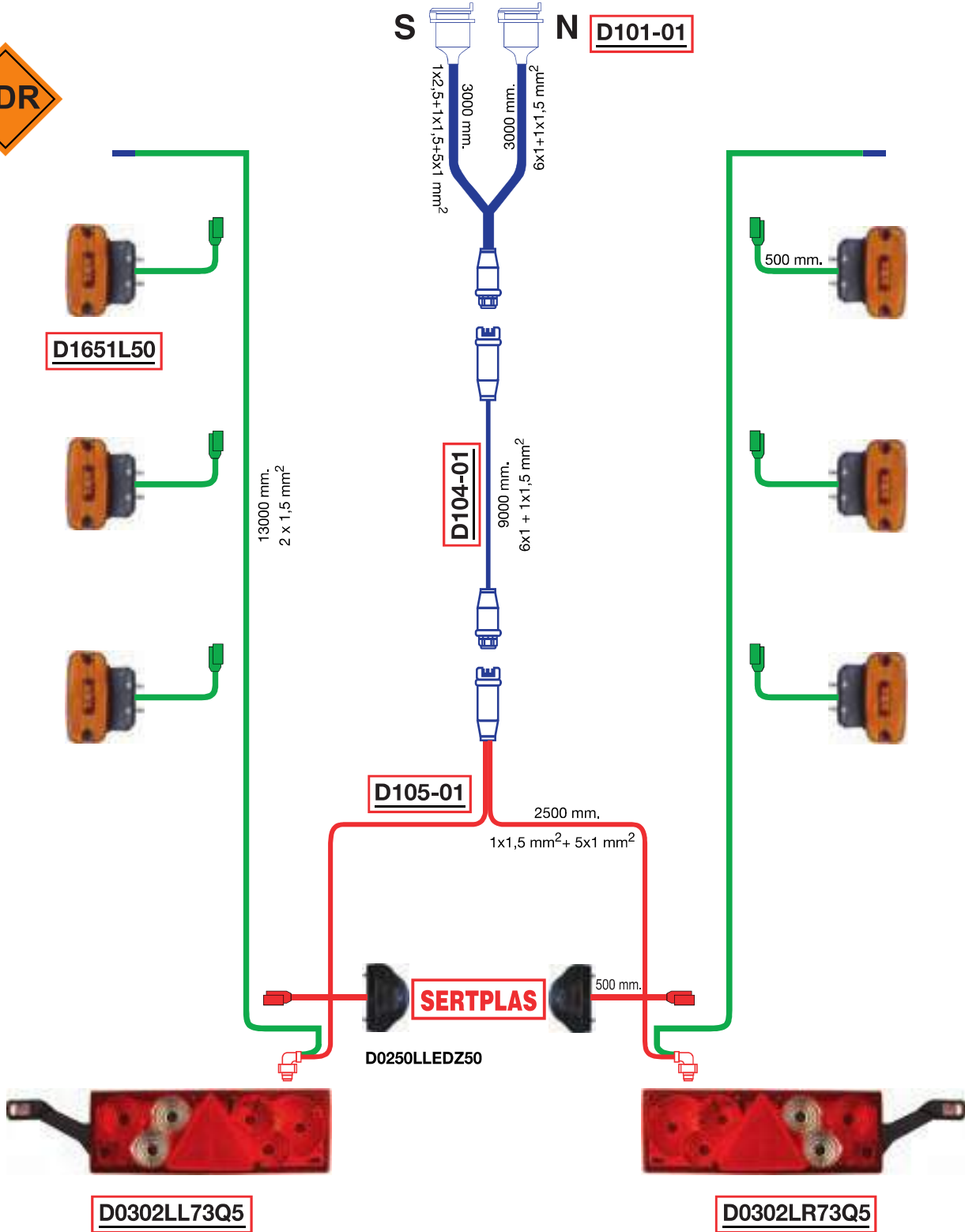

We would be pleased to supply DORSETs according to your special requirements.
(Özel isteklerinize uygun olarak dorset üretilebilir.)

Complete Lighting Sets for Trailer (DORSET)
Komple Aydınlatma Seti (DORSET)

TRAIL-TECH

D105Q126

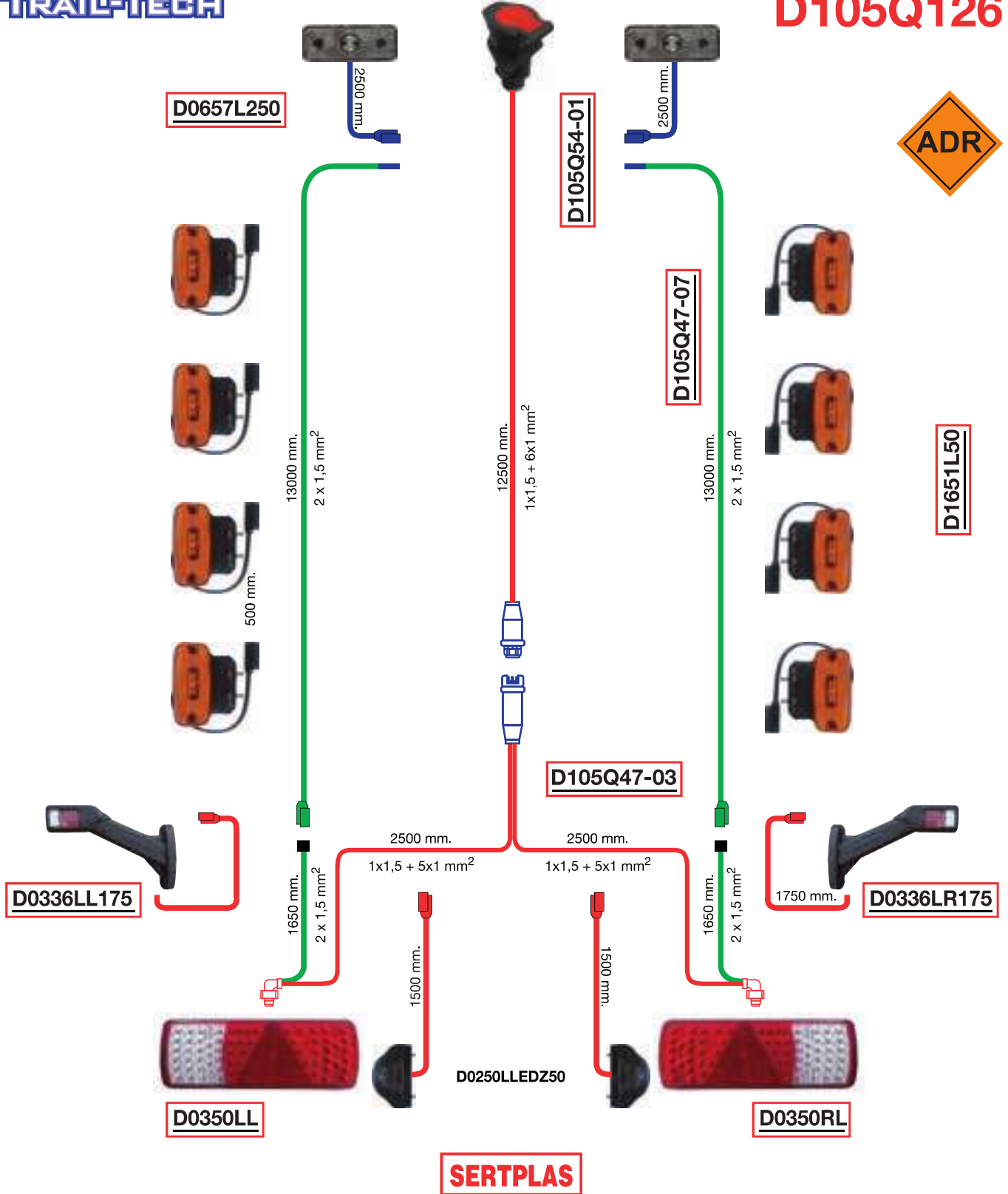

We would be pleased to supply DORSETs according to your special requirements.
(Özel isteklerinize uygun olarak dorset üretilebilir.)

Complete Lighting Sets for Trailer (DORSET)
Komple Aydınlatma Seti (DORSET)

TRAIL-TECH

D105Q122

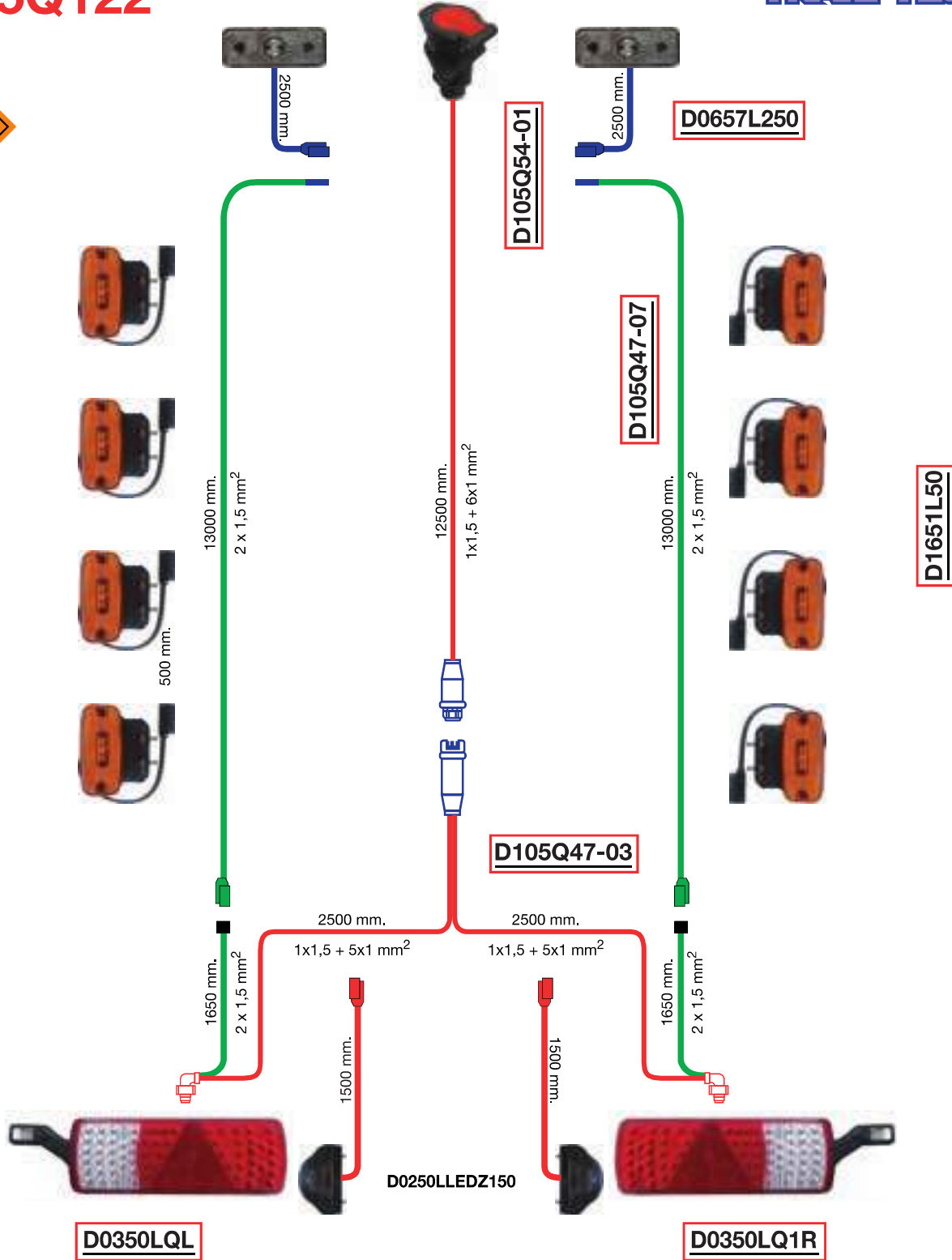

We would be pleased to supply DORSETs according to your special requirements.
(Özel isteklerinize uygun olarak dorset üretilebilir.)

Complete Lighting Sets for Trailer (DORSET) | Komple Aydınlatma Seti (DORSET)

TRAIL-TECH

D110Q12

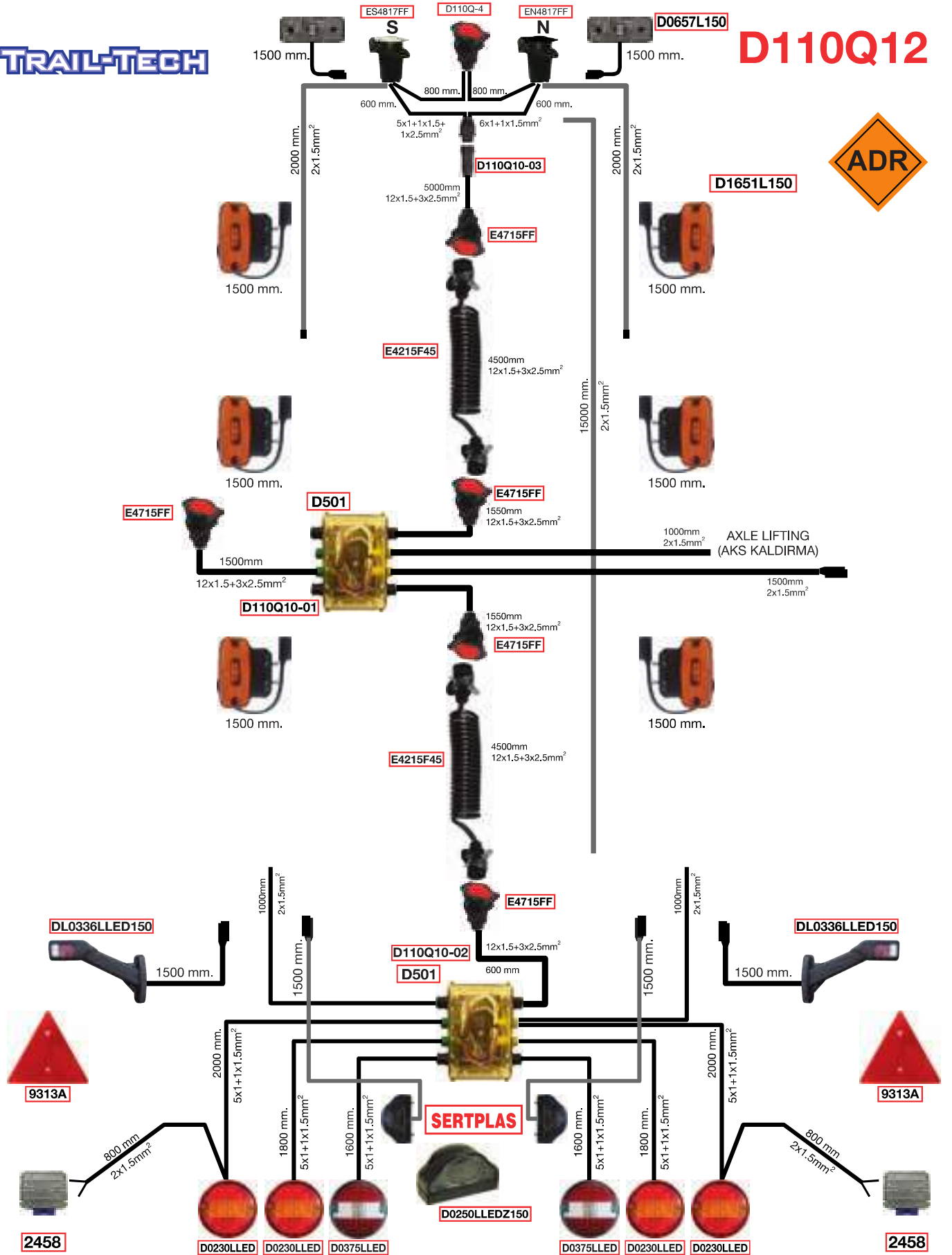

We would be pleased to supply DORSETs according to your special requirements.
(Özel isteklerinize uygun olarak dorset üretilir.)

The Lighting Set Compliant with ECE 48 Rev.6

TRAIL-TECH

D101Q1WS

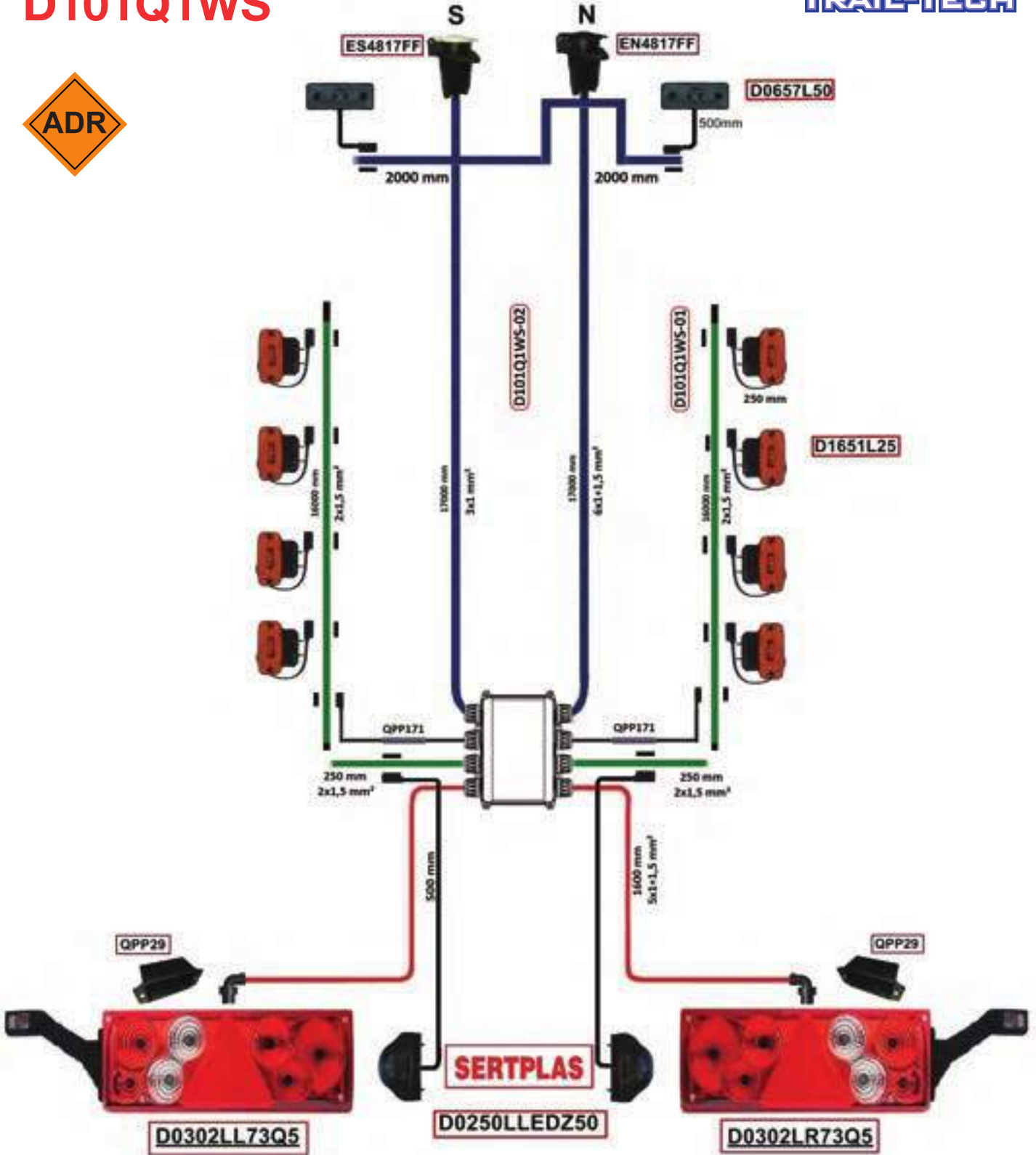

* This Product is designed as a solution for ECE 48 Revision 6. When the vehicle (Trucks and all towing vehicles) turns left or right direction, side marker lights work as a direction indicator lamp through control gear.

We would be pleased to supply DORSETs according to your special requirements.
(Özel isteklerinize uygun olarak dorset üretilebilir.)

Complete Lighting Sets for Trailer (DORSET) | Komple Aydınlatma Seti (DORSET)

TRAILER SET FOR 12V VEHICLES

D105Q170

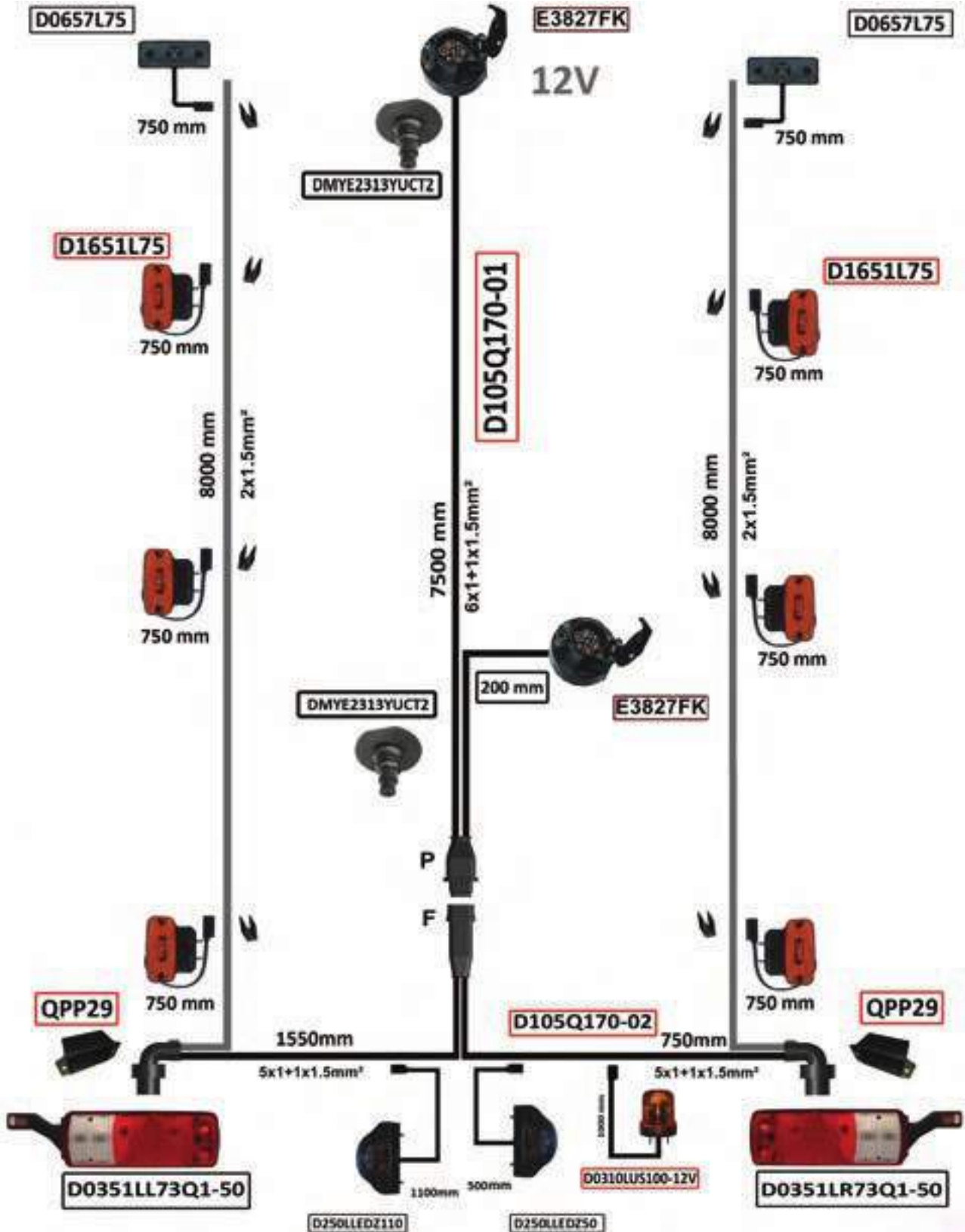

Socket Junction Box For Dorsets

N Type, S Type and 15 Poles Sockets Include



Without Cable

D200

Socket Junction Box For Dorsets

N Type, S Type and 15 Poles Sockets Include



Cable Length: 500 mm

D100-01

Junction Box With 15 Core Cable



Cable Length: 500 mm

D300

Junction Box With 15 Core Cable



Polycarbon Case
Cable Length: 500 mm

D301

Junction Box With 8 & 14 Port



Without Cable

D500.8
D500.14

D500

Junction Box With 8 & 14 Port Polycarbon Case



Without Cable

D501.8
D501.14

D501

Junction Box With AMP Socket



D107-03

Junction Box With AMP Socket



Polycarbon Case **D107-031**

7 Core Electrical Cable with N/S Type Socket



Cable Length: 3000 mm

DSTY09.3M

D101-01

Junction Box With AMP Socket 2 Pieces AMP Type Socket Include



Cable Length:
15 Core 500 mm
7 Core 1600 mm (x2)

D100-06

Junction Box With AMP Socket 2 Pieces AMP Type Socket Include



Polycarbon Case
Cable Length:
15 Core 500 mm
7 Core 1600 mm (x2)

D100-061

2 Core Electrical Cable with S Type Socket 2 Poles Plug Include



Cable Length: 17000 mm

DSTY02.17M.FS01

D107-01

2 Core Electrical Cable with N Type Socket 2 Poles Plug Include



Cable Length: 17000 mm

DSTY01.17M.FS35

D107-02

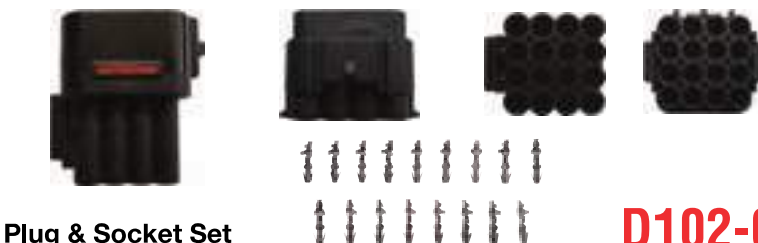

Plug & Socket Set

D102-06

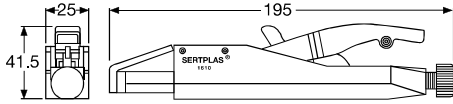

Order No: **DM1610**
Ek Çene Pensesi
Plier for Quick Connector
(For Lighting Set Use)

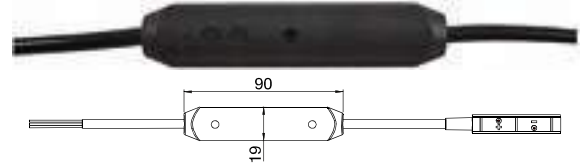

Order No: **QPP171**
Yan İşaret Kontrol Sistemi
Side Marker Control Gear

Makes all side markers flash simultaneously with the direction indicator in the rear lamp
Arka lambadaki yön göstergesi ile tüm yan işaretlerin aynı anda yanıp sönmelerini sağlar.

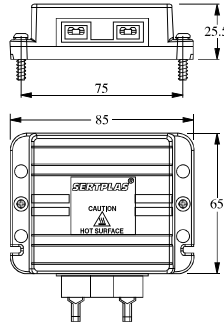

Order No: **2458**
24V LED Arıza Giderici
24V LED Error Free Box

2 Core Square Sheathed Cables Kit (Right / Left)



D100-05

Cable Length: 17000 mm

DSTY20.17MS/Y

Tail Lamp Cables Kit (Austrian Plug type) (Right/Left 2500 mm x 2)
2 Core Square Sheathed Cable Include 500 mm x 2)



D104-03

DSTY12.250.250

15 Poles Electrical Cable For Dorsets

Electrical Cable For Tail Lamps
(Austrian Plug type and Female Flat Terminal Connection)



Cable Length: 1600 mm

DSTY14.160S(Y)

D400R (Right)

D400L (Left)

D100-04

Cable Length: 16000 mm **DSTY10.15.16M**

Tail Lamp Electrical Cable (With AMP Plug Type)



D107-06

Cable Length: 2500 mm

DSTY22.250

CABLES (KABLÖLAR)	SIZE (KESİT) (mm ²)	ORDER NO (SİPARİŞ NO)
	(3x2,5 mm ² +12x1,5 mm ²)	QKL15DISO
	(2x2,5mm ² +8x1mm ²)	QKL10D732AQ
	(2x2,5mm ² +6x1mm ²)	QKL8D225A
	(2x2,5mm ² +5x1mm ²)	QKL7D225N
	(2x2,5mm ² +4x1mm ²)	QKL6D225N
	(1x2,5mm ² +7x1,5mm ²)	QKL8D125A15
	(1x2,5mm ² +6x1mm ²)	QKL7D125A
	(2x2,5mm ² +3x1mm ²)	QKL5D215S
	(1x1,5mm ² +6x1mm ²)	QKL7D115N
	(1x2,5mm ² +1x1,5mm ² +5x1mm ²)	QKL7D125S
	1x1,5mm ² +5x1mm ² (Right)	QKL6D115R
	1x1,5mm ² +5x1mm ² (Left)	QKL6D115L
	2x1mm ² (Rectangular)	QKL/210KR
	2x1,5mm ² (Rectangular)	QKL/215KR
	2x1,5mm ² (Round)	QKL2D73S
	3x1mm ² (For Power Supply)	QKL3D743S
	3x1mm ² (For Lift)	QKL3D732S

Ref.Digits at the end denotes the length of the cable in cm.
Kod sonundaki haneler kablo uzunluđu içindir (cm).



D1651L50



D1381LUS50



D1652L50

5 LED



D1309L50



D0260L50

1 LED



D1654L50



D0653L50



D0657L50



D0250LZ50 With Bulb
D0250LLEDZ50 With LED



with LED

D0336LR175 (Right)
D0336LL175 (Left)



with bulb
D0084LR175 (Right)
D0084LL175 (Left)

with LED
D0084LLEDL175 (Right)
D0084LLEDL175 (Left)



LED Trailer Rear Lamp (with Ultrasonic Sensor)

LED Dorse Arka Stop Lambası (Ultrasonik Sensörlü)



0012L

Functions Stop, Side Marker, Position, Reflector, Rear Fog, Indicator, Front Position, Reverse
Fonksiyonlar Stop, Yan Marker, Pozisyon, Reflektör, Arka Sis, Sinyal, Ön Pozisyon, Geri Vites

A Light Control Gear kit is integrated to product against to Indicator Failures. This Light Control Gear (LCG) enables truck&trailers with a non LED conform electrical system to operate LED lamps by adjust the electrical properties.

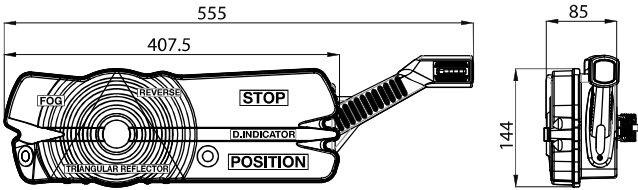

Order Number | Sipariş Kodu



Left
Sol

Right
Sağ

0012LQ1L

0012LQ1R



20 pcs Adet

Fastening Bolts | Bağlantı Civataları

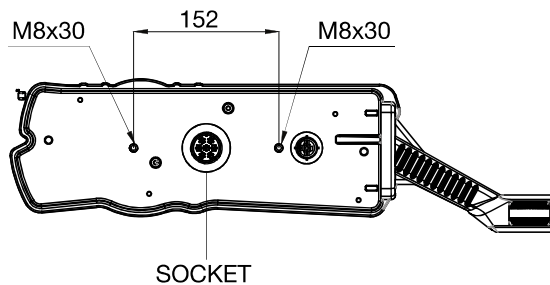

0106L



LED Trailer Rear Lamp

LED Dorse Arka Stop Lambası



Functions Rear Fog, Stop, Position, Reverse, Indicator

Fonksiyonlar Arka Sis, Stop, Pozisyon, Geri Vites, Sinyal

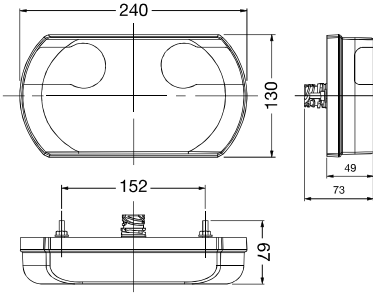

A Light Control Gear kit is integrated to product against to Indicator Failures. This Light Control Gear (LCG) enables truck&trailers with a non LED conform electrical system to operate LED lamps by adjust the electrical properties.



* 24V version of product includes LCG

12V /24V

Order Number | Sipariş Kodu



Left
Sol

Right
Sağ

Left
Sol

Right
Sağ

0106LL-24V

0106LR-24V

0106LL-12V

0106LR-12V



20 pcs Adet

Fastening Bolts | Bağlantı Civataları

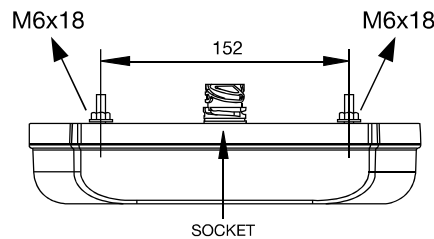

LED Trailer Rear Lamp

0010

LED Dorse Arka Stop Lambası

Functions Stop, Side Marker, Position, Reflector, Rear Fog, Indicator, Front Position, Reverse

Fonksiyonlar Stop, Yan Marker, Pozisyon, Reflektör, Arka Sis, Sinyal, Ön Pozisyon, Geri Vites



Without LED Marker
LED Boynuzsuz

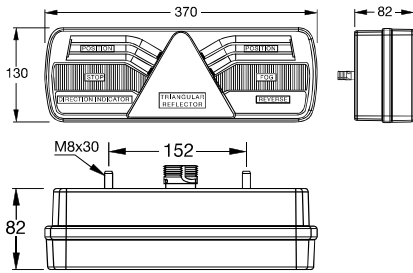

With LED Marker
LED Boynuzlu

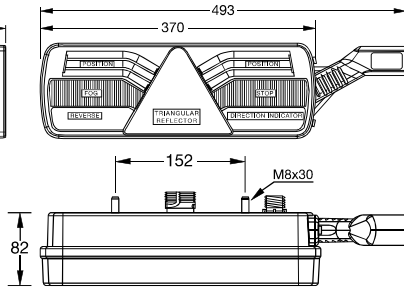

A Light Control Gear kit is integrated to product against to Indicator Failures. This Light Control Gear (LCG) enables truck&trailers with a non LED conform electrical system to operate LED lamps by adjust the electrical properties.

Order Number | Sipariş Kodu



Left
Sol

0010LL



Right
Sağ

0010LR



Left with LED Marker
LED Boynuzlu Sol

0010LQ1L



Right with LED Marker
LED Boynuzlu Sağ

0010LQ1R



18 pcs Adet



14 pcs Adet

Left with LED Dynamic Marker
Dinamik Kayan LED Sinyalli Sol

Right with LED Dynamic Marker
Dinamik Kayan LED Sinyalli Sağ



0010LL-S



0010LR-S



18 pcs Adet

Fastening Bolts | Bağlantı Civataları

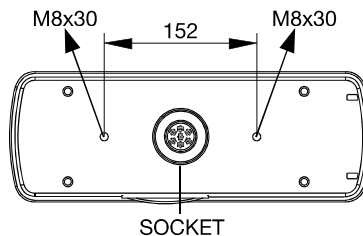

0350

LED Trailer Rear Lamp

LED Dorse Arka Stop Lambası



Functions Stop, Side Marker, Position, Reflector, Rear Fog, Indicator, Front Position, Reverse

Fonksiyonlar Stop, Yan Marker, Pozisyon, Reflektör, Arka Sis, Sinyal, Ön Pozisyon, Geri Vites



A Light Control Gear kit is integrated to product against to Indicator Failures. This Light Control Gear (LCG) enables truck&trailers with a non LED conform electrical system to operate LED lamps by adjust the electrical properties.

Without LED Marker
LED Boynuzsuz

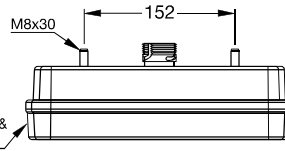
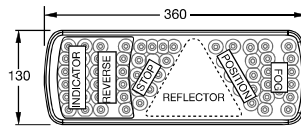

SIDE MARKER & REFLECTOR

With LED Marker
LED Boynuzlu

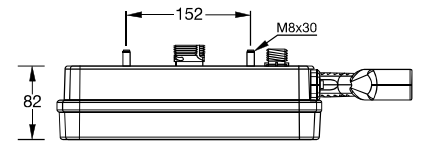
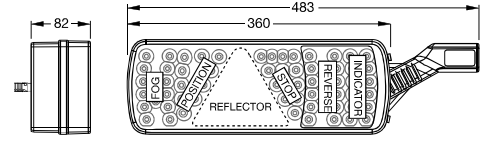

Order Number | Sipariş Kodu



Left
Sol

Right
Sağ

Left with LED Marker
LED Boynuzlu Sol

Right with LED Marker
LED Boynuzlu Sağ

0350LL

0350LR

0350LQ1L

0350LQ1R



18 pcs Adet



14 pcs Adet

Fastening Bolts | Bağlantı Civataları

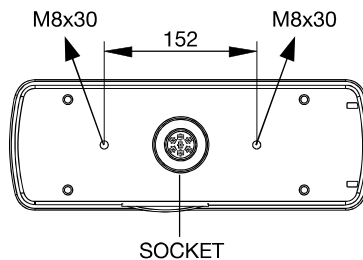

Trailer Rear Lamp

0351

Dorse Arka Stop Lambası

Functions Reverse, Stop, Side Marker, Position, Reflector, Rear Fog, Indicator, Num. Plate, Front Position, End Outline Marker, Rear Position

Fonksiyonlar Geri Vites, Stop, Yan Marker, Pozisyon, Reflektör, Arka Sis, Sinyal, Plaka, Ön Pozisyon, Uç Yan Marker, Arka Pozisyon



Without Marker
Boynuzsuz

With Marker
Boynuzlu

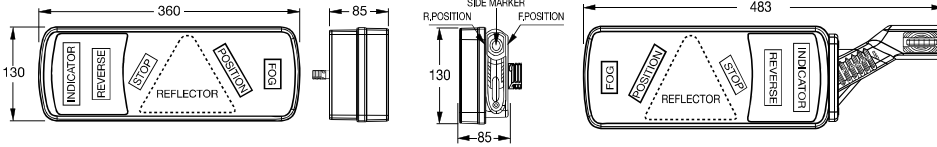

Order Number | Sipariş Kodu



Left
Sol

Right
Sağ

Left with Marker
LED Boynuzlu Sol

Right with Marker
LED Boynuzlu Sağ

0351LL

0351LR

0351LL73Q1

0351LR73Q1



18 pcs Adet



14 pcs Adet

Lens Code | Cam Kodu



0351CL

0351CR

Fastening Bolts | Bağlantı Civataları

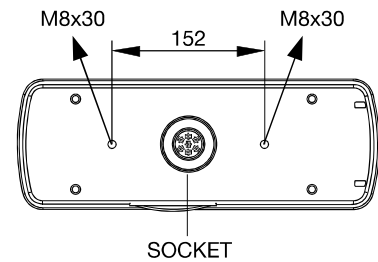

24 pcs Adet

0302

Trailer Rear Lamp

Dorse Arka Stop Lambası



Functions Reverse, End-Outline Marker, Stop, Side Marker, Position, Reflector, Rear Fog, Indicator, Num. Plate

Fonksiyonlar Geri Vites, Uç Yan Marker, Stop, Yan Marker, Pozisyon, Reflektör, Sinyal, Arka Sis, Plaka

Fastening Bolts | Bağlantı Civataları

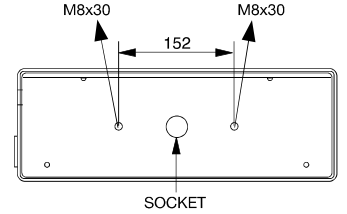
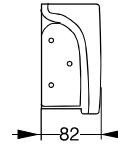
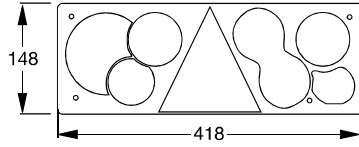

Order Number | Sipariş Kodu



Left
Sol

Socket Type
Bağlantı Tipi

Right
Sağ



0302LL61 With Gromet & Cable (30 cm)



0302LR61

13 pcs Adet

0302LL73 Austrian Blade Socket



0302LR73

13 pcs Adet

Lens Code | Cam Kodu



0302CL

0302CR



16 pcs Adet

Trailer Rear Lamp

Dorse Arka Stop Lambası

0302

Functions Reverse, End Outline Marker, Stop, Side Marker, Position, Reflector, Rear Fog, Indicator, Num. Plate, Front Position, Rear Position

Fonksiyonlar Geri Vites, Uç Yan Marker, Stop, Yan Marker, Pozisyon, Reflektör, Sinyal, Arka Sis, Plaka, Ön Pozisyon, Arka Pozisyon

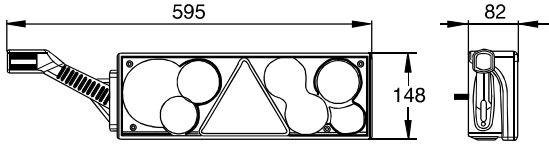

0302LL73Q5

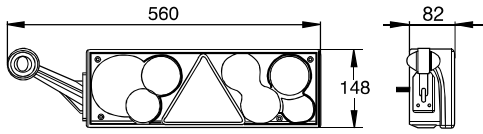

0302LL73Q1

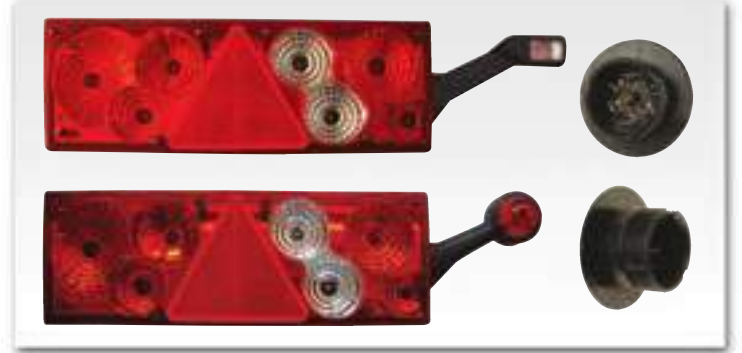

Order Number | Sipariş Kodu

Left
SolRight
SağLeft
SolRight
Sağ

0302LL73Q5

0302LR73Q5

0302LL73Q1

0302LR73Q1



20 pcs Adet



20 pcs Adet

Lens Code | Cam Kodu



0302CL



0302CR



16 pcs Adet

Fastening Bolts | Bağlantı Civataları

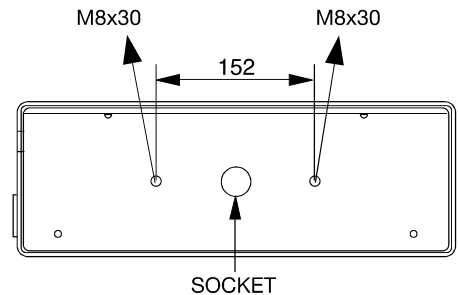

SOCKET

0376-0378



LED Trailer Rear Lamp LED Dorse Arka Stop Lambası

Functions	Stop, Side Marker, Position, Reflector, Rear Fog, Indicator, Reverse, Front Position, Num. Plate
Fonksiyonlar	Stop, Yan Marker, Pozisyon, Reflektör, Arka Sis, Sinyal, Geri Vites, Ön Pozisyon, Plaka



A Light Control Gear kit is integrated to product against to Indicator Failures. This Light Control Gear (LCG) enables truck&trailers with a non LED conform electrical system to operate LED lamps by adjust the electrical properties.

With LED Side Lamp
LED Yan Lambalı

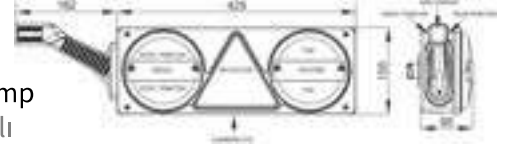

Without LED Side Lamp
LED Yan Lambasız

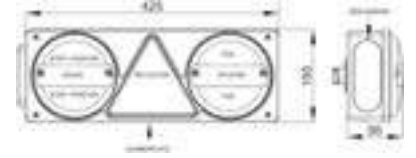

Order Number | Sipariş Kodu



0376LL73

0376LR73

0378LL73

0378LR73



20 pcs Adet



14 pcs Adet

Fastening Bolts | Bağlantı Civataları

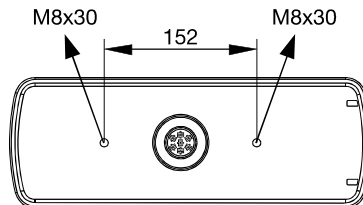

Trailer Rear Lamp

0030

Dorse Arka Stop Lambası

Functions Reverse, End-Outline Marker, Stop, Side Marker, Position, Reflector, Rear Fog, Indicator, Num. Plate

Fonksiyonlar Geri Vites, Uç Yan Marker, Stop, Yan Marker, Pozisyon, Reflektör, Sinyal, Arka Sis, Plaka

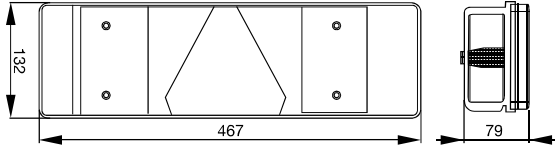

Order Number | Sipariş Kodu

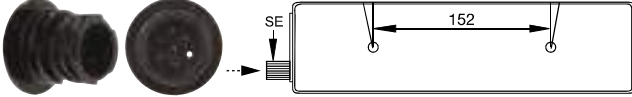
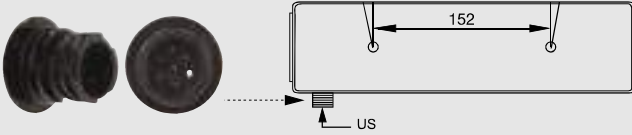
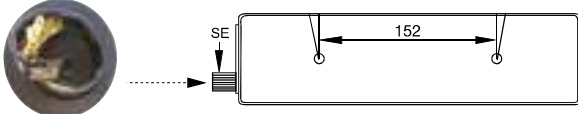
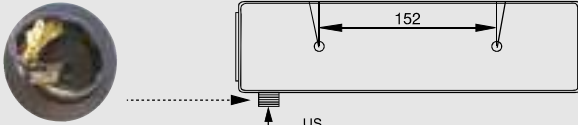

Left Sol	Socket Type Bağlantı Tipi	Right Sağ	
0030LL742T SE Type AMP		0030LR742T	14 pcs Adet
0030LL741T US Type AMP		0030LR741T	14 pcs Adet
0030LL612T SE Gromet and Cable (30cm)		0030LR612T	14 pcs Adet
0030LL611T US Gromet and Cable (30 cm)		0030LR611T	14 pcs Adet

Lens Code | Cam Kodu



0030CLT

0030CRT



30 pcs Adet

Fastening Bolts | Bağlantı Civataları

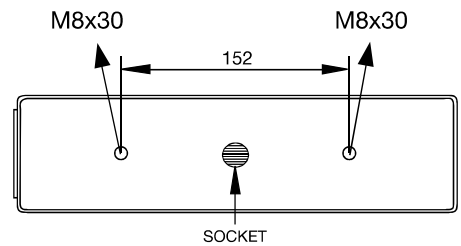

0030

Trailer Rear Lamp

Dorse Arka Stop Lambası



Functions Reverse, End-Outline Marker, Stop, Side Marker, Position, Reflector, Rear Fog, Indicator, Num. Plate

Fonksiyonlar Geri Vites, Uç Yan Marker, Stop, Yan Marker, Pozisyon, Reflektör, Sinyal, Arka Sis, Plaka

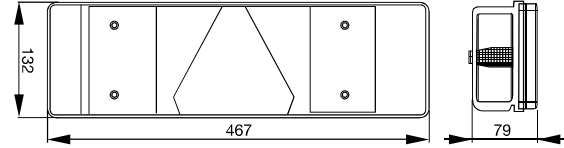

Order Number | Sipariş Kodu



Left Sol	Socket Type Bağlantı Tipi	Right Sağ	
0030LL51T	Universal Gromet with Cable (60 cm)	0030LR51T	14 pcs Adet
0030LL61T	With Gromet & Cable (30 cm)	0030LR61T	14 pcs Adet
0030LL72T	Schlemmer Socket	0030LR72T	14 pcs Adet
0030LL73T	Austrian Blade Socket	0030LR73T	14 pcs Adet
0030LL74T	AMP Socket	0030LR74T	14 pcs Adet
0030LL75T	Daf Socket	0030LR75T	14 pcs Adet

Lens Code | Cam Kodu



0030CLT

0030CRT



30 pcs Adet

Fastening Bolts | Bağlantı Civataları

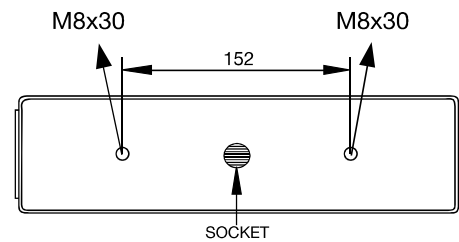

Trailer Rear Lamp

0023

Dorse Arka Stop Lambası

Functions Reverse, End-Outline Marker, Stop, Side Marker, Position, Reflector, Rear Fog, Indicator, Num. Plate

Fonksiyonlar Geri Vites, Uç Yan Marker, Stop, Yan Marker, Pozisyon, Reflektör, Sinyal, Arka Sis, Plaka

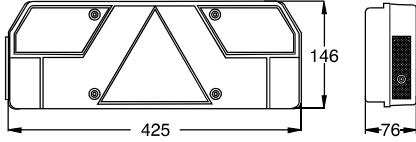

Order Number | Sipariş Kodu



Left Sol	Socket Type Bağlantı Tipi	Right Sağ	
0023LL50	Universal Gromet	0023LR50	13 pcs Adet
0023LL51	Universal Gromet with Cable (60 cm)	0023LR51	13 pcs Adet
0023LL72	Schlemmer Socket	0023LR72	13 pcs Adet
0023LL73	Austrian Blade Socket	0023LR73	13 pcs Adet
0023LL74	AMP Socket	0023LR74	13 pcs Adet

Lens Code | Cam Kodu

**0023CL****0023CR**

16 pcs Adet

Fastening Bolts | Bağlantı Civataları

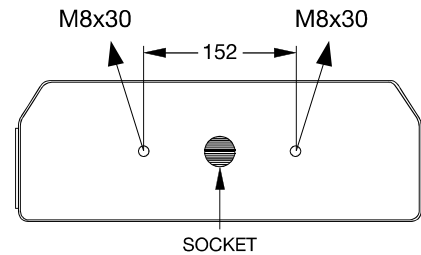

0023

Trailer Rear Lamp

Dorse Arka Stop Lambası



Functions Reverse, End-Outline Marker, Stop, Side Marker, Position, Reflector, Rear Fog, Indicator, Num. Plate

Fonksiyonlar Geri Vites, Uç Yan Marker, Stop, Yan Marker, Pozisyon, Reflektör, Sinyal, Arka Sis, Plaka

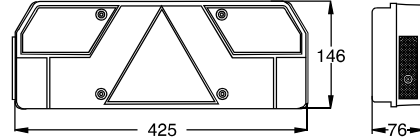

Order Number | Sipariş Kodu



Left Sol	Socket Type Bağlantı Tipi	Right Sağ	
0023DLL50	Universal Gromet	0023DLR50	13 pcs Adet
0023DLL51	Universal Gromet with Cable (60 cm)	0023DLR51	13 pcs Adet
0023DLL72	Schlemmer Socket	0023DLR72	13 pcs Adet
0023DLL73	Austrian Blade Socket	0023DLR73	13 pcs Adet
0023DLL74	AMP Socket	0023DLR74	13 pcs Adet

Lens Code | Cam Kodu



0023DCL

0023DCR



16 pcs Adet

Fastening Bolts | Bağlantı Civataları

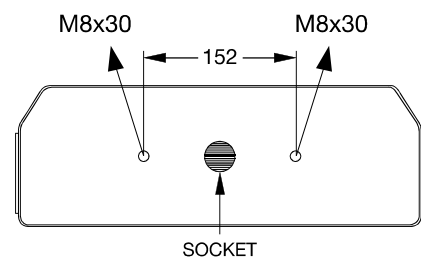

Trailer Rear Lamp

Dorse Arka Stop Lambası

0023

Functions Reverse, End-Outline Marker, Stop, Side Marker, Position, Reflector, Rear Fog, Indicator, Num. Plate

Fonksiyonlar Geri Vites, Uç Yan Marker, Stop, Yan Marker, Pozisyon, Reflektör, Sinyal, Arka Sis, Plaka

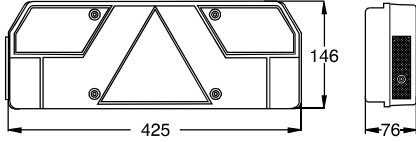

Order Number | Sipariş Kodu



Left Sol	Socket Type Bağlantı Tipi	Right Sağ	
0023LL50Q	Universal Gromet	0023LR50Q	13 pcs Adet
0023LL51Q	Universal Gromet with Cable (60 cm)	0023LR51Q	13 pcs Adet
0023LL72Q	Schlemmer Socket	0023LR72Q	13 pcs Adet
0023LL73Q	Austrian Blade Socket	0023LR73Q	13 pcs Adet
0023LL74Q	AMP Socket	0023LR74Q	13 pcs Adet

Lens Code | Cam Kodu

**0023CLQ****0023CRQ**

16 pcs Adet

Fastening Bolts | Bağlantı Civataları

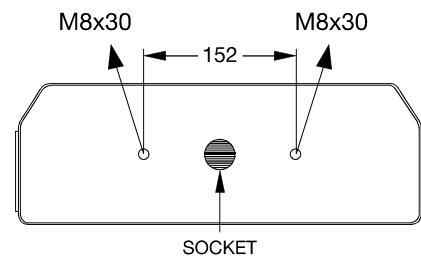

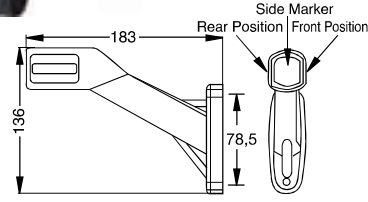

12V /24V



Position Lamp with LED
Led'li Pozisyon Lambası

Order Number | Sipariş Kodu

Left | Sol

Right | Sağ

0336LL

0336LR

50 pcs Adet

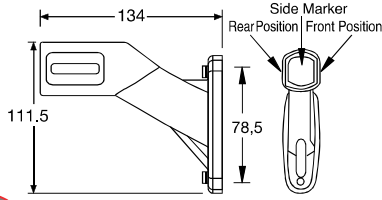

12V /24V



Position Lamp with LED
Led'li Pozisyon Lambası

Order Number | Sipariş Kodu

Left | Sol

Right | Sağ

0387LL

0387LR

50 pcs Adet

Cable Length
Kablo Uzunluğu
25 cm

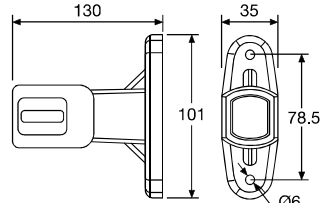

12V /24V



Position Lamp with LED
Led'li Pozisyon Lambası

Order Number
Sipariş Kodu

0338L

100 pcs Adet

Cable Length
Kablo Uzunluğu
25 cm

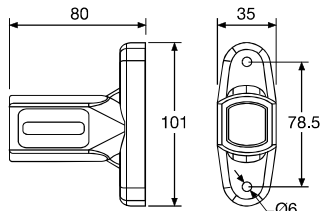

12V /24V



Position Lamp with LED
Led'li Pozisyon Lambası

Order Number
Sipariş Kodu

0339L

100 pcs Adet

Cable Length
Kablo Uzunluğu
25 cm

Position Lamp

Pozisyon Lambası

Order Number Sipariş Kodu		
With Bulb Ampullü	With LED Left Ledli Sol	With LED Right Ledli Sağ

0084LEMKB 0084LLEDLKB 0084LLEDRKB

50 pcs Adet

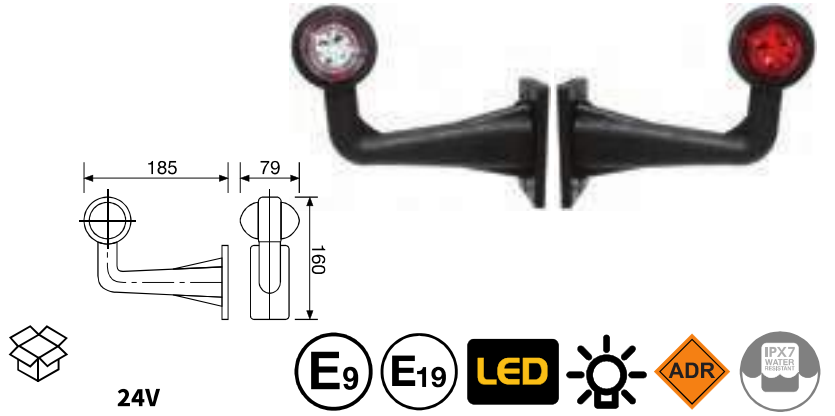

Position Lamp

Pozisyon Lambası

Order Number Sipariş Kodu		
With Bulb Ampullü	With LED Left Ledli Sol	With LED Right Ledli Sağ

0085LEMKB 0085LLEDLKB 0085LLEDRKB

50 pcs Adet

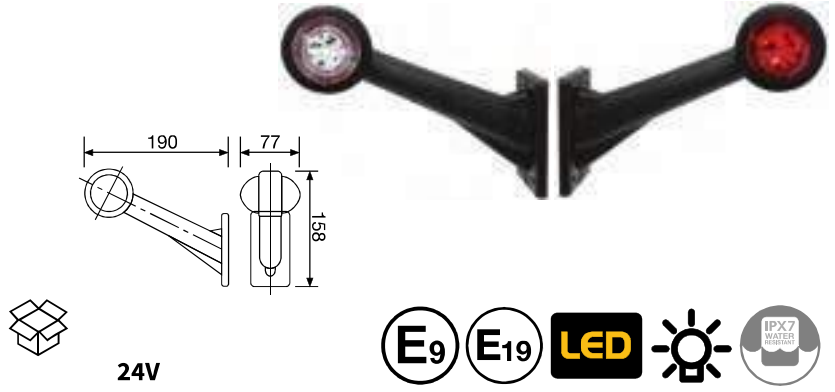

Position Lamp

Pozisyon Lambası

Order Number Sipariş Kodu		
With Bulb Ampullü	With LED Left Ledli Sol	With LED Right Ledli Sağ

0123LEMKB 0123LLEDLKB 0123LLEDRKB

50 pcs Adet

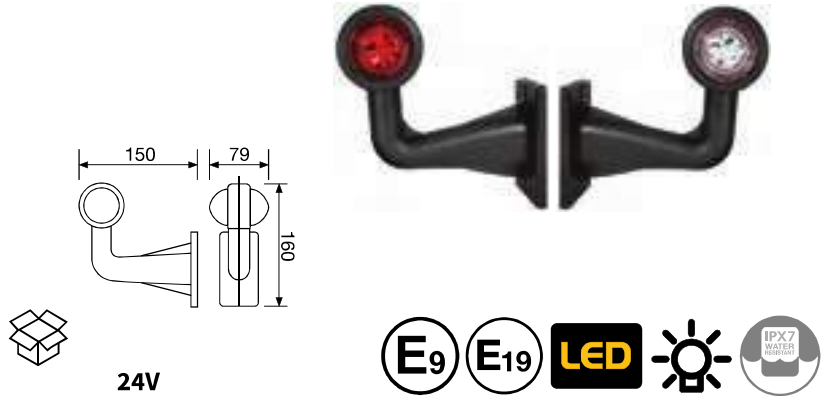

Position Lamp

Pozisyon Lambası

Order Number Sipariş Kodu		
With Bulb Ampullü	With LED Left Ledli Sol	With LED Right Ledli Sağ

0124LEMKB 0124LLEDLKB 0124LLEDRKB

50 pcs Adet

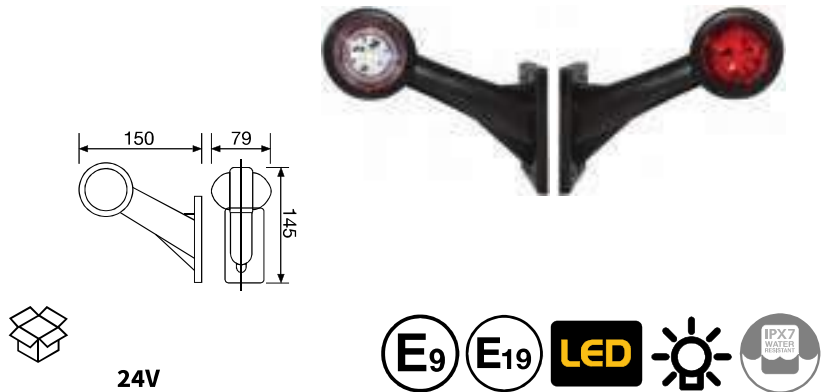

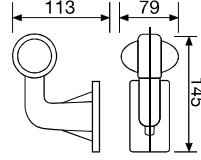

24V



Position Lamp

Pozisyon Lambası

Order Number | Sipariş Kodu

With Bulb
Ampullü

With LED Left
Ledli Sol

With LED Right
Ledli Sağ

0207LEMKB 0207LLEDLKB 0207LLEDRKB

50 pcs Adet

Position Lamp

Pozisyon Lambası

Order Number | Sipariş Kodu

With Bulb | Ampullü

With LED | Ledli

0140LEMKB

0140LLEDKB

50 pcs Adet

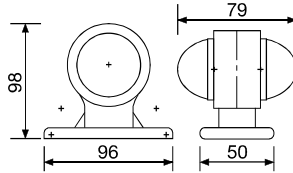

24V



Lens with LED for Side Lamps

Yan Lambalar için LED'li Lens

Order Number
Sipariş Kodu

0084CLED

50 pcs Adet

Cable Length
Kablo Uzunluğu
50 cm

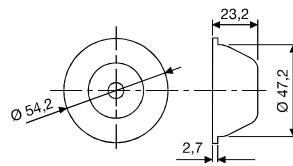
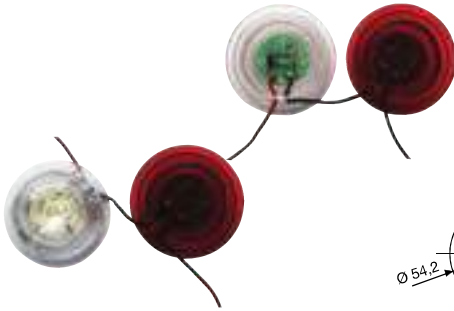

24V



Position Lamp

Pozisyon Lambası

Order Number
Sipariş Kodu

0200LEMKB

40 pcs Adet

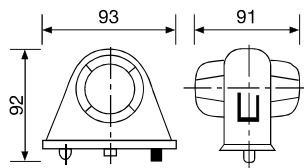

24V



LED Side Marker Lamps

LED'li Yan İşaret Lambaları

Function Fonksiyon	Order Number Sipariş Kodu	LED Strip Lamps LED Şerit Lamba
Side Marker Yan Marker	0365LUS	
Rear Position Arka Pozisyon	0365LUK	
Front Position Ön Pozisyon	0365LUB	

100 pcs Adet

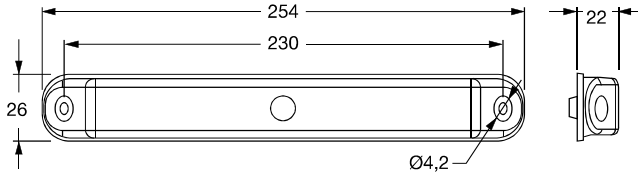

24V



Standard products work on 24 V. They can also be produced to work on 12 V according to your demands.
Standart ürünler 24 V olarak üretilir. Fakat taleplerinize göre ürün 12 V olarak da üretilebilmektedir.

Cable Length | Kablo Uzunluğu : 30 cm

Function Fonksiyon	Order Number Sipariş Kodu	Opaque LED Strip Lamps LED Opak Şerit Lamba
Side Marker Yan Marker	0410LUS12-24V	
Rear Position Arka Pozisyon	0410LUK12-24V	
Front Position Ön Pozisyon	0410LUB12-24V	

100 pcs Adet

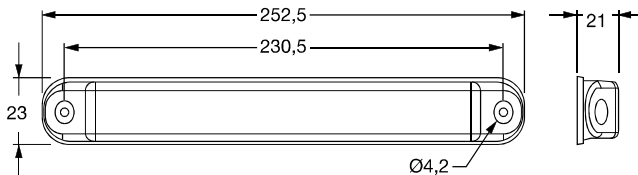



12V - 24V



Cable Length | Kablo Uzunluğu : 30 cm

LED Side Marker Lamps

LED'li Yan İşaret Lambaları

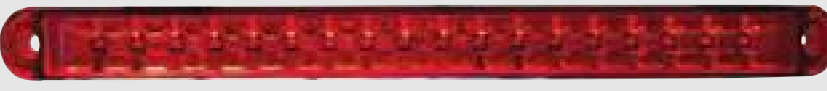
LED Strip Lamps (Includes 18 LEDs) with Leak Proofing Gromet 18 LEDli Lamba Sızdırmaz Grometli	Order Number Sipariş Kodu	Function Fonksiyon
	0411LUS12-24V	Side Marker Yan Marker
	0411LUK12-24V	Rear Position Arka Pozisyon
	0411LUB12-24V	Front Position Ön Pozisyon
	0412LUK12-24V	Third Stop Üçüncü Stop



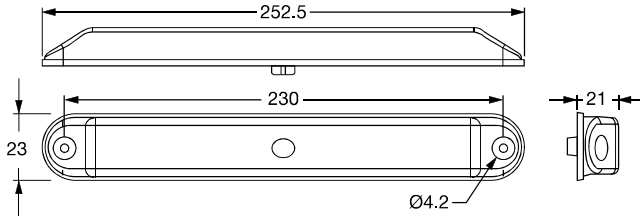

LED

12V - 24V

Cable Length | Kablo Uzunluğu: 30 cm

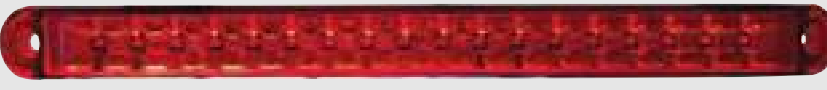

100 pcs Adet

LED Lamps (Includes 18 LEDs) with Filling Material 18 LEDli Dolgu Maddeli	Order Number Sipariş Kodu	Function Fonksiyon
	0408LUS12-24V	Side Marker Yan Marker
	0408LUK12-24V	Rear Position Arka Pozisyon
	0408LUB12-24V	Front Position Ön Pozisyon
	0409LUK12-24V	Third Stop Üçüncü Stop

LED

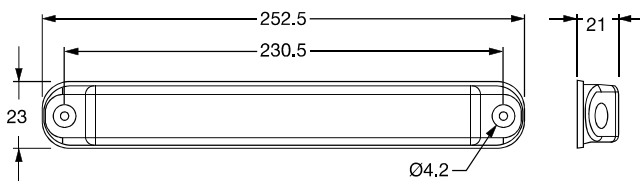

12V - 24V

Cable Length | Kablo Uzunluğu: 30 cm



100 pcs Adet

LED Side Marker Lamps
LED'li Yan İşaret Lambaları

Function Fonksiyon	Order Number Sipariş Kodu	Side Marker Lamps (3 LEDs) Yan İşaret Lambası (3 LEDli)
Side Marker Yan Marker	0413LUS12-24V	
Rear Position Arka Pozisyon	0413LUK12-24V	
Front Position Ön Pozisyon	0413LUB12-24V	

150 pcs Adet



Cable Length : 30 cm
Kablo Uzunluğu

12V - 24V

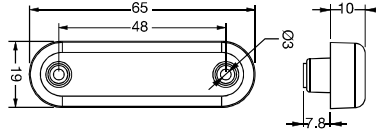

Function Fonksiyon	Order Number Sipariş Kodu	Side Marker Lamps (Includes 6 LEDs) with Filling Material LEDli Yan İşaret Lambası (6 LEDli) Dolgu Maddeli
Side Marker Yan Marker	0308LUS12-24V	
Rear Position Arka Pozisyon	0308LUK12-24V	
Front Position Ön Pozisyon	0308LUB12-24V	

500 pcs Adet



Cable Length : 30 cm
Kablo Uzunluğu

12V - 24V

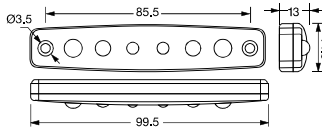

Function Fonksiyon	Order Number Sipariş Kodu	Side Marker Lamps (Includes 6 LEDs) with Leak Proofing Gromet LEDli Yan İşaret Lambası (6 LEDli) Sızdırmazlık Grometli
Side Marker Yan Marker	0307LUS12-24V	
Rear Position Arka Pozisyon	0307LUK12-24V	
Front Position Ön Pozisyon	0307LUB12-24V	

500 pcs Adet



Cable Length : 30 cm
Kablo Uzunluğu



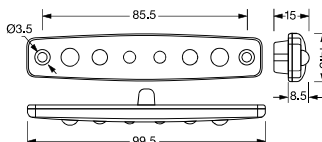

12V - 24V







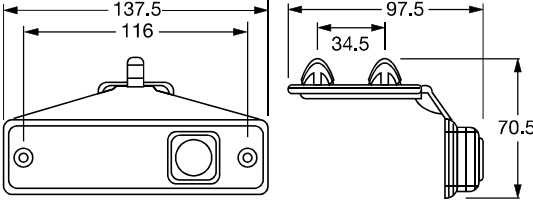

Truck, Trailer LED Side Marker Lamps

Çekici ve Dorse LED'li Yan Lamba

Side Marker Lamp with Single LED Tek LEDli Yan İşaret Lambası	Order Number Sipariş Kodu		Function Fonksiyon	
	Without Bracket Braketsiz	With Bracket Braketli		
		0381LUS 0381LUS12-24V	1381LUS 1381LUS12-24V	Side Marker Yan Marker
		0381LUK 0381LUK12-24V	1381LUK 1381LUK12-24V	Rear Position Arka Pozisyon
		0381LUB 0381LUB12-24V	1381LUB 1381LUB12-24V	Front Position Ön Pozisyon

				150 pcs Adet	100 pcs Adet	
Cable Length Kablo Uzunluğu : 30 cm				12/24V		

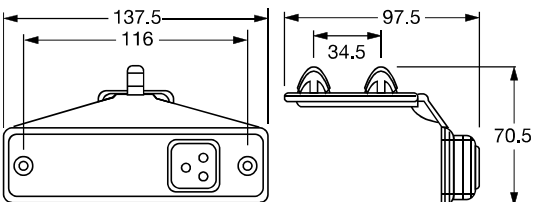
Side Marker Lamp with LED (3 LEDs) LEDli Yan İşaret Lambası (3 LEDli)	Order Number Sipariş Kodu		Function Fonksiyon	
	Without Bracket Braketsiz	With Bracket Braketli		
		0383LUS 0383LUS12-24V	1383LUS 1383LUS12-24V	Side Marker Yan Marker
		0383LUK 0383LUK12-24V	1383LUK 1383LUK12-24V	Rear Position Arka Pozisyon
		0383LUB 0383LUB12-24V	1383LUB 1383LUB12-24V	Front Position Ön Pozisyon

				150 pcs Adet	100 pcs Adet	
Cable Length Kablo Uzunluğu : 30 cm				12/24V		

Side Marker Lamp with LED (5 LEDs) with Holder
LEDli Yan İşaret Lambası (5 LEDli) - Ayarlanabilir Civatalı

Order Number Sipariş Kodu	
Without Bracket Braketsiz	With Bracket Braketli
0309LUS	1309LUS
60 pcs Adet	Cable Length Kablo Uzunluğu 25 cm

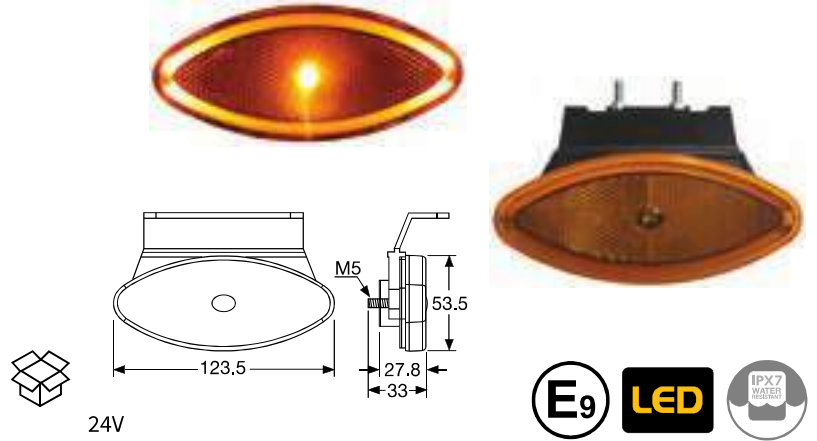

Side Marker Lamp with LED (5 LEDs) with Holder
LEDli Yan İşaret Lambası (5 LEDli) - Ayarlanabilir Civatalı

Order Number Sipariş Kodu	
Without Bracket Braketsiz	With Bracket Braketli
0650LUS	1650LUS
60 pcs Adet	Cable Length Kablo Uzunluğu 25 cm

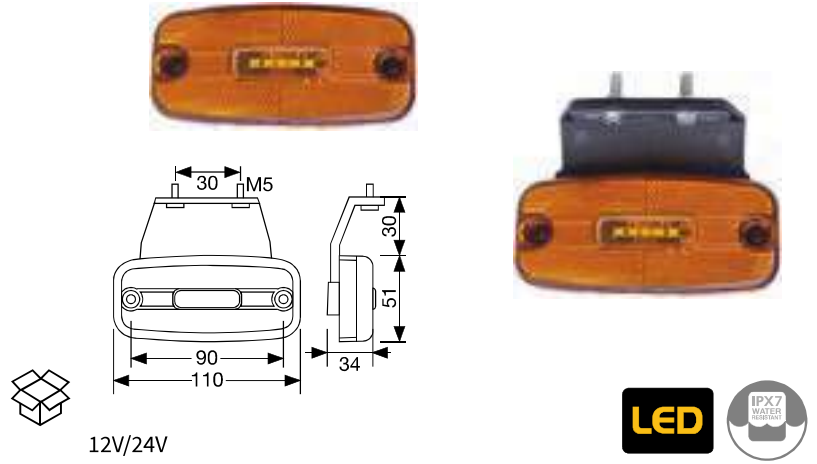

Side Marker Lamp with LED (3 LEDs) with Holder
LEDli Yan İşaret Lambası (3 LEDli) - Ayarlanabilir Civatalı

Order Number Sipariş Kodu	
Without Bracket Braketsiz	With Bracket Braketli
0651LUS	1651LUS
60 pcs Adet	Cable Length Kablo Uzunluğu 25 cm

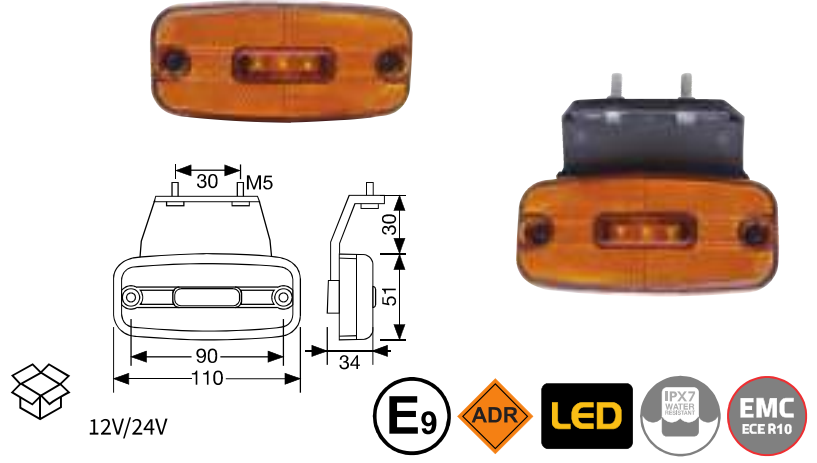

Side Marker Lamp with LED (1 LED) with Holder
LEDli Yan İşaret Lambası (1 LEDli) - Ayarlanabilir Civatalı

Order Number Sipariş Kodu	
Without Bracket Braketsiz	With Bracket Braketli
0652LUS	1652LUS
60 pcs Adet	Cable Length Kablo Uzunluğu 25 cm

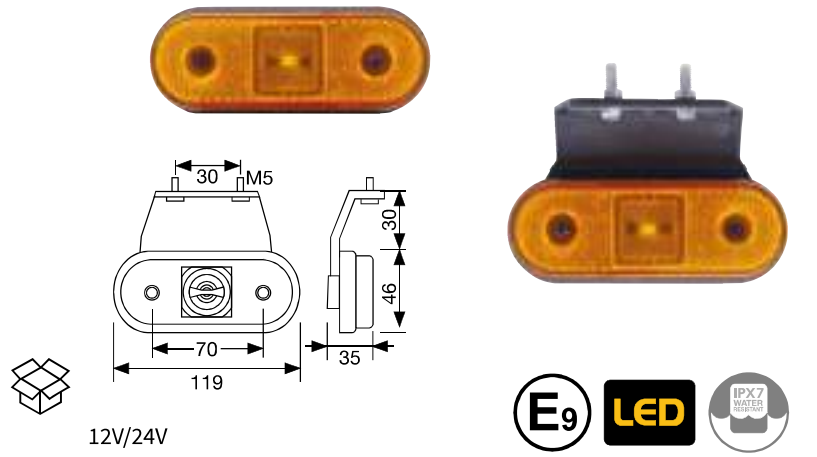

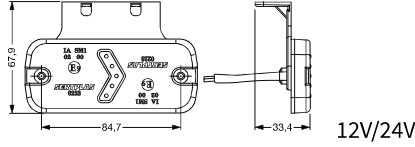
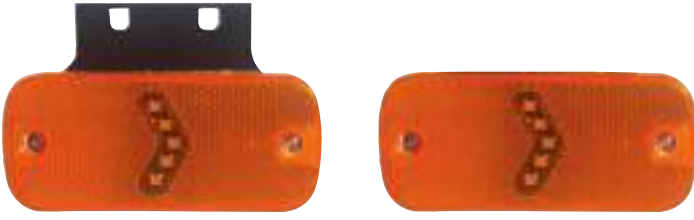

Side Marker Lamp with LED (5 LEDs) with Holder
LEDli Yan İşaret Lambası (5 LEDli) - Ayarlanabilir Civatalı

Order Number | Sipariş Kodu

Without Bracket
Braketsiz

With Bracket
Braketli

0223LUS

1223LUS

72 pcs Adet

Cable Length
Kablo Uzunluğu
25 cm

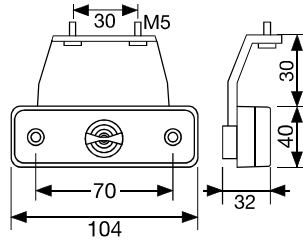

Side Marker Lamp with LED (1 LED) with Holder
LEDli Yan İşaret Lambası (1 LEDli) - Ayarlanabilir Civatalı

Order Number | Sipariş Kodu

Without Bracket
Braketsiz

With Bracket
Braketli

0654LUS

1654LUS

60 pcs Adet

Cable Length
Kablo Uzunluğu
25 cm

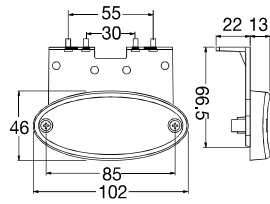

Side Marker Lamp with LED (1 LED)
LEDli Yan İşaret Lambası (1 LEDli)

Order Number | Sipariş Kodu

Without Bracket
Braketsiz

With Bracket
Braketli

0324LUS

1324LUS

Cable Length Kablo Uzunluğu 50 cm

72 pcs Adet

60 pcs Adet

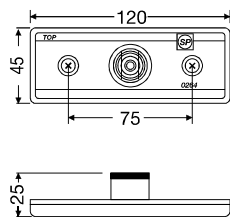

Side Marker Lamp with LED (4 LEDs)
LEDli Yan İşaret Lambası (4 LEDli)

Order Number | Sipariş Kodu

Without Bracket
Braketsiz

With Bracket
Braketli

0238LUS12-24V

0239LUS12-24V

Cable Length Kablo Uzunluğu 25 cm

36 pcs Adet

60 pcs Adet

Rear Position Lamp with LED (1 LED) LEDli Arka Pozisyon Lambası (1 LEDli)

Order Number | Sipariş Kodu

Without Bracket
Braketsiz

With Bracket
Braketli

0653LUK

1653LUK

Cable Length Kablo Uzunluğu 25 cm

60 pcs Adet

50 pcs Adet



0,72W/24V

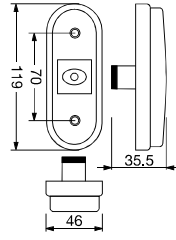

Side Marker Lamp with LED (1 LED) LEDli Yan İşaret Lambası (1 LEDli)

Order Number | Sipariş Kodu

Without Bracket
Braketsiz

With Bracket
Braketli

0653LUS

1653LUS

Cable Length Kablo Uzunluğu 25 cm

60 pcs Adet

50 pcs Adet



0,72W/24V

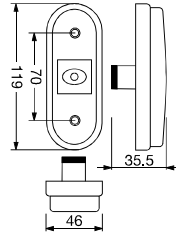

Front Position Lamp with LED (1 LED) LEDli Ön Pozisyon Lambası (1 LEDli)

Order Number | Sipariş Kodu

Without Bracket
Braketsiz

With Bracket
Braketli

0657LUB

1657LUB

Cable Length Kablo Uzunluğu 25 cm

36 pcs Adet

60 pcs Adet



12/24V

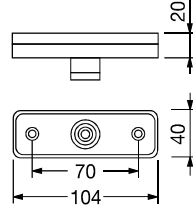

Front Position Lamp with LED (1 LED) LEDli Ön Pozisyon Lambası (1 LEDli)

Order Number | Sipariş Kodu

Without Bracket
Braketsiz

With Bracket
Braketli

0657LE

1657LE

Cable Length Kablo Uzunluğu 25 cm

72 pcs Adet

60 pcs Adet



12/24V

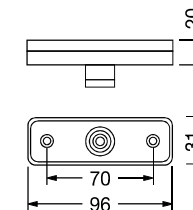

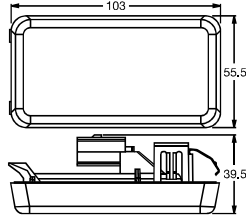
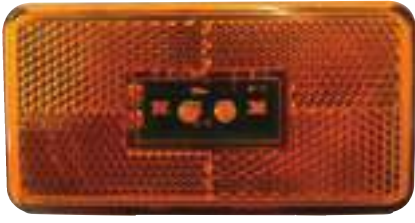

12/24V



Side Marker Lamp with LED (4 LEDs)
LEDli Yan İşaret Lambası (4 LEDli)

Order Number
Sipariş Kodu

0247LUS

72 pcs Adet

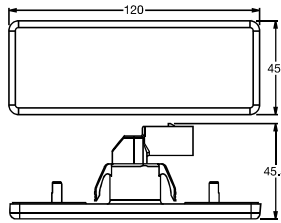

12/24V



Side Marker Lamp with LED (6 LEDs)
LEDli Yan İşaret Lambası (6 LEDli)

Order Number
Sipariş Kodu

0240LUS

36 pcs Adet

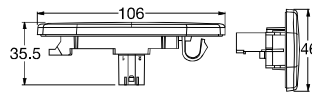

12/24V



Side Marker Lamp with LED (1 LED)
LEDli Yan İşaret Lambası (1 LEDli)

Order Number
Sipariş Kodu

0241LUS

36 pcs Adet



Socket Type | Soket Tipi

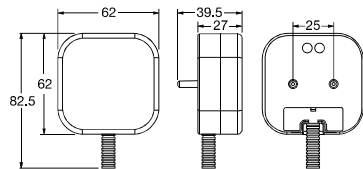

12/24V



Side Marker Lamp with LED (4 LEDs)
LEDli Yan İşaret Lambası (4 LEDli)

Order Number
Sipariş Kodu

0273LUS

Order Number
Sipariş Kodu

0268LUS

45 pcs Adet

Cable Length
Kablo Uzunluğu
140 cm

Side Marker Lamp | Yan İşaret Lambası

Order Number Sipariş Kodu	
Without Socket Soketsiz	With Socket Soketli

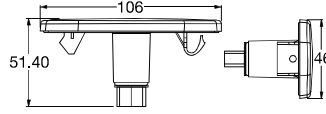

0242LUSQ

0242LUS

Socket Set : QSK25-ST5

36 pcs Adet



BULB : W5W



Side Marker Lamp | Yan İşaret Lambası

Order Number Sipariş Kodu	
With Bracket Braketli	

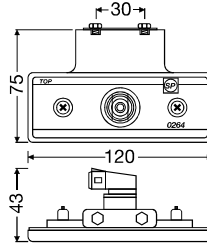

Socket Type | Soket Tipi
0259LUS 0260LUS



0259LUS
0260LUS

60 pcs Adet



BULB : W5W



Side Marker Lamp | Yan İşaret Lambası

Order Number Sipariş Kodu	
Without Bracket Braketsiz	

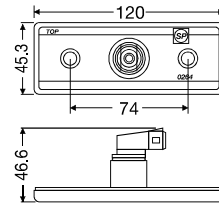

Socket Type | Soket Tipi
0264LUS 0265LUS



0264LUS
0265LUS

36 pcs Adet



BULB : W5W



Side Marker Lamp | Yan İşaret Lambası

Order Number Sipariş Kodu	
Without Socket Soketsiz	With Socket Soketli

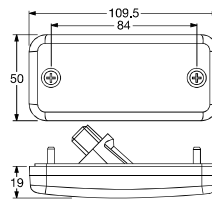

Socket Set : QSK18-ST5



0249LUSQ

0249LUS

50 pcs Adet



BULB : W5W





Side Marker Lamp with LED (3 LEDs) with Holder
LEDli Yan İşaret Lambası (3 LEDli) - Ayarlanabilir Civatalı

Order Number | Sipariş Kodu
Without Bracket | Braketsiz

0279LUS



12/24V



50 pcs Adet

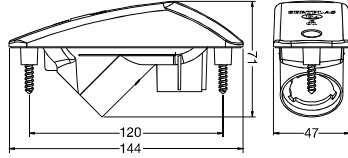

Side Indicator Lamp
Yan Sinyal Lambası

Order Number
Sipariş Kodu

0275LUS



24V/21W



32 pcs Adet

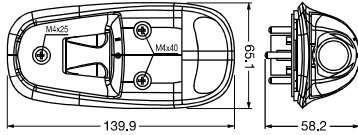

Front Position Lamp
Ön Pozisyon Lambası

Order Number
Sipariş Kodu

0276LUB



24V/5W



44 pcs Adet

Product Includes Bulb

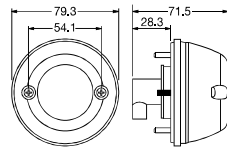

Side Indicator Lamp
Yan Sinyal Lambası

Order Number | Sipariş Kodu
With Socket
Soketli

0272LUS

Socket Type | Soket Tipi



24V/21W



35 pcs Adet

SATURN LAMP - EX-PROOF LIGHTING

SATURN LAMP - PATLAYICI ORTAMLAR İÇİN ÇALIŞMA LAMBASI

Saturn Lamp Ex-Proof Lamp for Marine&Vehicles
Satürn Lamba - Kara ve Deniz Araçları için
Patlamaya Dayanıklı Lamba

Order Number | Sipariş Kodu

With Bulb
Ampullü

With LED 12/24V
LEDli 12/24V

0011LU

0011LLED12-24V

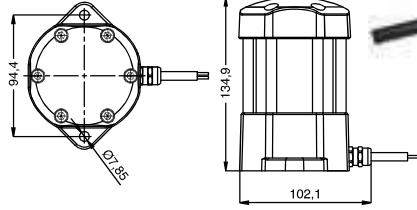

10 pcs Adet



Sector Kullanım Yeri	Marine/Vehicles and Exproof Ambience Kara/Deniz Araçları ve Maden gibi Patlayıcı Ortamlar
Operation Condition Çalışma Koşulları	60°C (-) 30°C 60°C (-) 30°C
Lighting Sources Işıklandırma Kaynağı	Bulb/LED Ampul/LED
Resistance Dayanım	Atex Level 4 T4 Atex
Base Body Gövde Malzemesi	Aluminium Alüminyum
Lens Material Cam Malzemesi	Tempered Class Temper Cam
Cable Detail Kablo Detayı	H05RR-F H05RR-F
Cable Section Kablo Kesiti	2x1 mm ² 2x1 mm ²
Cable Length Kablo Boyu	1 meters 1 metre



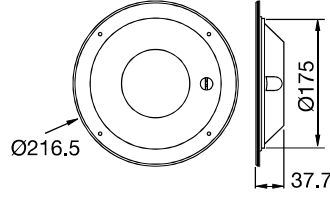

12V/24V



Indoor - Ceiling Lamp

İç Aydınlatma Lambası

Order Number | Sipariş Kodu

With Bulb Ampullü	With LED 24V LEDli 24V	With LED 12V LEDli 12V	Lens Code Cam Kodu
----------------------	---------------------------	---------------------------	-----------------------

0341L 0341LLED24V 0341LLED12V 0341CU

40 pcs Adet

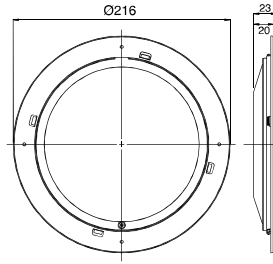

12V/24V



Indoor - Ceiling Lamp

İç Aydınlatma Lambası

Order Number
Sipariş Kodu

0355LUB

24 pcs Adet

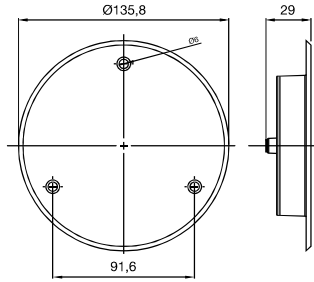

12V/24V



Indoor - Ceiling Lamp

İç Aydınlatma Lambası

Order Number
Sipariş Kodu

0356LUB

36 pcs Adet

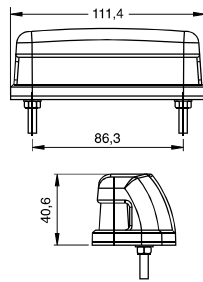

12V/24V



Number Plate Lamp with LED (5 LEDs)

LEDli Plaka Lambası (5 LEDli)

Order Number
Sipariş Kodu

0092LUB

Cable Length Kablo Uzunluğu 50 cm

60 pcs Adet

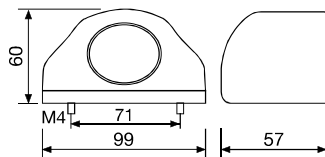

12V/24V



Number Plate Lamp with Bulb (5 Watt) with LED

Plaka Lambası Ampullü (5 Watt) LEDli

Order Number | Sipariş Kodu

With Bulb Ampullü	With LED LEDli
----------------------	-------------------

0250LUZ

0250LLEDZ

Cable Length Kablo Uzunluğu 50 cm

35 pcs Adet

50 pcs Adet

Triangular Reflector | Üçgen Reflektör

(Red, White, Yellow Colours available)

(Kırmızı, Beyaz, Sarı renklerde üretilebilir)

Order Number
Sipariş KoduImperforate
Deliksiz**9313A****9313B**

500 pcs Adet

500 pcs Adet

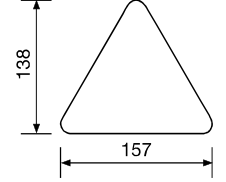
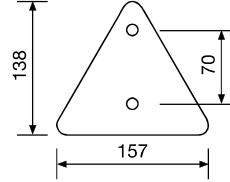

Marker Reflector Triangular | Üçgen Reflektör

(Uniform Different Colours available)

(Farklı renklerde üretilebilir)

Order Number
Sipariş KoduImperforate
Deliksiz**9312****9315**

500 pcs Adet

500 pcs Adet

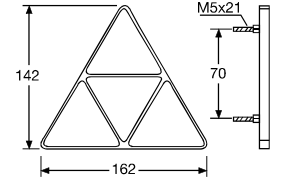
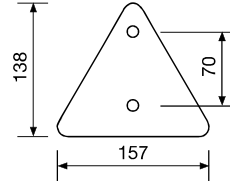

Rectangular Reflector Black Base

Dikdörtgen Siyah Tabanlı Reflektör

Order Number
Sipariş Kodu**9411UAK**

500 pcs Adet

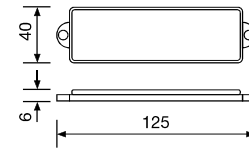

Warning Triangular Reflector

Üçgen Uyarı Reflektör

Order Number
Sipariş Kodu**9046Q1**

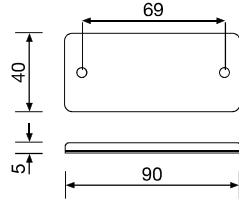

Marker Reflector Rectangular | Dörtgen Reflektör
(Uniform Different Colours available / Farklı renklerde üretilebilir)

Order Number | Sipariş Kodu

White | Beyaz Amber | Amber

9419UAB-B

9419UAS-B

500 pcs Adet

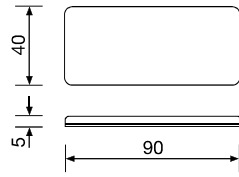
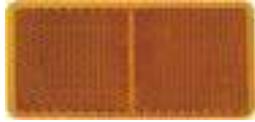
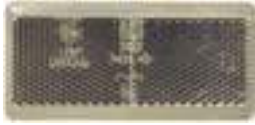

Marker Reflector Rectangular Sticker Type
Dörtgen Reflektör Etiket Tip
(Uniform Different Colours available / Farklı renklerde üretilebilir)

Order Number | Sipariş Kodu

White | Beyaz Amber | Amber

9429UAB-B

9429UAS-B

500 pcs Adet



E9

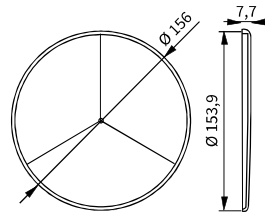

Triangular Reflector (with Adhesive)
Üçgen Reflektör (Yapıştırıcılı)

Order Number
Sipariş Kodu

9316

100 pcs Adet



E9

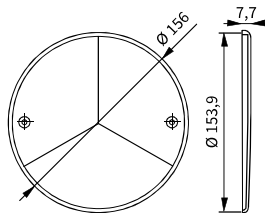

Triangular Reflector (with Screw Holes)
Üçgen Reflektör (Vidalı Montaj)

Order Number
Sipariş Kodu

9317

100 pcs Adet



E9

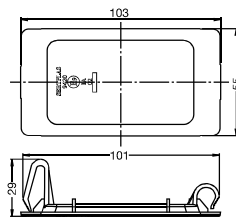

Rectangular Yellow Reflector with White Base
Beyaz Tabanlı Sarı Dikdörtgen Reflektör

Order Number
Sipariş Kodu

9420

50 pcs Adet



E9

Pneumatic P.A. 12 Polyamide Tubes for Air Brake Systems

Pnömatik P.A. 12 Poliamid Tır Dorse Havalı Fren Hortumları

Material Materyal	PA 12
Color Renk	Black
Coil Size Sarımlar Uzunluğu	25m, 50m, 100m, 500m available
Branding Markalama	Tube I.D., O.D. / Material / Spec. I.D., O.D. / Materyal / Spek



Min. Bend
Radius at 23° C
Min. Bükülme
Çapı 23° C' de

Working
Pressure at 23° C
Çalışma Basıncı
23° C' de

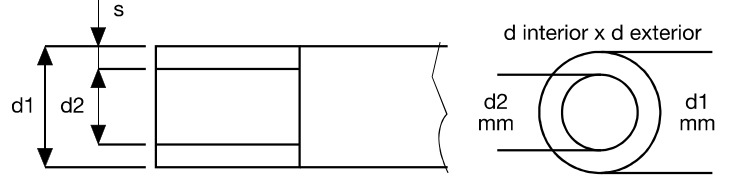

Inner Diameter İç Çap	Outer Diameter Dış Çap	Wall Thickness Duvar Kalınlığı	r (mm)	Po (bar)	Order Number Sipariş Kodu
2	4	1	20	45	QHTPA0204Z
3	4	0.5			QHTPA0304Z
4	6	1	35	27	QHTPA0406Z
6	8	1	40	19	QHTPA0608Z
6	9	1.5	45	27	QHTPA0609Z
6	10	2			QHTPA0610Z
7	10	1.5	70	23	QHTPA0710Z
7.5	10	1.25	75	19	QHTPA07510Z
8	10	1	50	15	QHTPA0810Z
8	11	1.5	65	21	QHTPA0811Z
9	11	1			QHTPA0911Z
8	12	2	60		QHTPA0812Z
9	12	1.5		19	QHTPA0912Z
10	12.5	1.25	80		QHTPA1012/5Z
10	14	2		21	QHTPA1014Z
11	15	2	95		QHTPA1115Z
12	15	1.5	100	15	QHTPA1215Z
12	16	2	115	19	QHTPA1216Z
14	18	2	115	17	QHTPA1418Z
16	20	2	100	16	QHTPA1620Z

Pneumatic Polyurethane Tubes

Pnömatik Poliüretan Hava Hortumları



Polyurethane Tubes Poliüretan Hortumlar	Inner d.xOuter d. İç Çap x Dış Çap (mm)	Length per Coil Bobin Uzunluğu (meters)	Yellow	Red	Blue	Black	White	Green
QHTPU0204	2 x 4	200			●	●	●	
QHTPU0304	3 x 4	200			●	●	●	
QHTPU0305	3x5	200			●	●	●	
QHTPU0406	4 x 6	200	●	●	●	●	●	●
QHTPU0407	4 x 7	100				●		
QHTPU0408	4 x 8	100		●		●		
QHTPU0508	5 x 8	100		●		●		
QHTPU05.508	5.5 x 8	100				●		
QHTPU0608	6 x 8	100	●	●	●	●	●	●
QHTPU0610	6 x 10	100		●		●		
QHTPU06.510	6.5 x 10	100		●		●		
QHTPU07.510	7.5 x 10	100				●		
QHTPU0810	8 x 10	100			●	●	●	
QHTPU0812	8 x 12	100		●		●		
QHTPU0911	9 x 11	100	●		●	●	●	
QHTPU0912	9 x 12	100				●		
QHTPU0913	9 x 13	50				●		
QHTPU1012	10 x 12	100				●	●	
QHTPU1014	10 x 14	50				●		
QHTPU1016	10 x 16	50		●		●		
QHTPU1216	12 x 16	50		●		●		●

Multi-core Cables | Çok Damarlı Kablolar



Order Number Sipariş Kodu	Section mm ² Kesit mm ²	Isolation Dış Kılıf	Operating Temperature Çalışma Sıcaklığı
QKL4515HT	3x2,5 + 12x1,5	TPE	-40 + 125°C
QKL4507HT	2x4 + 5x1,5	TPE	-40 + 125°C
QKL7D125HT	6x1,5 + 1x2,5	TPE	-40 + 125°C
QKL7D115N	1x1,5 + 6x1	PVC	-40 + 85°C
QKL3D743S	3x1	PVC	-40 + 85°C
QKL6D115L	1x1,5 + 5x1	PVC	-40 + 85°C
QKL6D115R	1x1,5 + 5x1	PVC	-40 + 85°C
QKL3D3035-ST5	3x0,35	PVC	-40 + 85°C
QKL/215KR	2x1,5	PVC	-40 + 85°C
QKL2D2035-ST5	2x0,35	PVC	-40 + 85°C
QKL2D210	2x1	PVC	-40 + 85°C
QKL7D125N	1x2,5 + 6x1	PVC	-40 + 85°C
QKL3D743S	3x1	PVC	-40 + 85°C
QKL600KRM	1x6	PVC	-40 + 85°C
QKL600SYH	1x6	PVC	-40 + 85°C
QKL/7TPU.ISO	6x1 + 1x1,5	TPU	-40 + 85°C
QKL4507TPU	2x4 + 5x1,5	TPU	-40 + 85°C
QKL4515TPU	3x2,5 + 12x1,5	TPU	-40 + 85°C
QKL4505TPU	2x4 + 3x1,5	TPU	-40 + 85°C
QKL4509TPU	8x1,5 + 1x2,5	TPU	-40 + 85°C
QKL41TPU-ST5	4x1	TPU	-40 + 85°C
QKL4513TPU	3x2,5 + 10x1,5	TPU	-40 + 85°C
QKL6D56105TRQ.TPU	5x6 + 1x0,5	TPU	-40 + 85°C
QKL6D525105TRQ.TPU	5x2,5 + 1x0,5	TPU	-40 + 85°C
QKL4D36105TRQ.TPU	3x6 + 1x0,5	TPU	-40 + 85°C
QKL4D32105TRQ.TPU	3x2,5 + 1x0,5	TPU	-40 + 85°C

Air Brake Connection Fittings for Trailer Treyler Havalı Fren Bağlantı Sekmanları

Order Number | Sipariş Kodu Size Boyut

Nipel Nipel



SP020404	4
SP020606	6
SP020707	7
SP020808	8
SP020909	9
SP021010	10
SP021111	11
SP021212	12
SP021414	14
SP021616	16

Order Number | Sipariş Kodu Size Boyut

Male Stud Run Elbow 90° Cıvatalı Erkek 90°



SP041804	1/8-4
SP041806	1/8-6
SP041406	1/4-6
SP043806	3/8-6
SP041808	1/8-8
SP041408	1/4-8
SP043808	3/8-8
SP041410	1/4-10
SP043810	3/8-10
SP041412	1/4-12
SP043812	3/8-12

Elbow 90° 90° Dirsek



SP050404	4 - 4
SP050606	6 - 6
SP050808	8 - 8
SP051010	10 - 10
SP051212	12 - 12

Reducer T Redüktör T



SP104406	4 - 4 - 6
SP106604	6 - 6 - 4
SP108806	8 - 8 - 6
SP106608	6 - 6 - 8
SP108810	8 - 8 - 10
SP10101008	10 - 10 - 8
SP10101012	10 - 10 - 12
SP10121210	12 - 12 - 10

Male Stud BSP P&M Branch T Erkek BSP P&M Dağıtım T



SP061804	1/8-4
SP061806	1/8-6
SP061406	1/4-6
SP063806	3/8-6
SP061808	1/8-8
SP061408	1/4-8
SP063808	3/8-8
SP061410	1/4-10
SP063810	3/8-10
SP061412	1/4-12
SP063812	3/8-12

Male Stud Run Tee BSP P&M Erkek BSP P&M Dağıtım T



SP071804	1/8-4
SP071806	1/8-6
SP071406	1/4-6
SP073806	3/8-6
SP071808	1/8-8
SP071408	1/4-8
SP073808	3/8-8
SP071410	1/4-10
SP073810	3/8-10
SP071412	1/4-12
SP073812	3/8-12

Tee T Şeklinde



SP030404	4
SP030606	6
SP030808	8
SP031010	10
SP031212	12

Reducer Redüktör



SP090604	6 - 4
SP090806	8 - 6
SP091008	10 - 8
SP091210	12 - 10

Air Brake Connection Fittings for Trailer Treyler Havalı Fren Bağlantı Sekmanları

Order Number Sipariş Kodu	Size	Boyut
-----------------------------	------	-------

Nipel Nipel	Order Number Sipariş Kodu	Size	Boyut
	SM020404	4	
	SM020606	6	
	SM020707	7	
	SM020808	8	
	SM020909	9	
	SM021010	10	
	SM021111	11	
	SM021212	12	
	SM021313	13	
	SM021414	14	
	SM021515	15	
SM021616	16		

Tee T Şeklinde	Order Number Sipariş Kodu	Size	Boyut
	SM030404	4	
	SM030606	6	
	SM030808	8	
	SM031010	10	
	SM031212	12	

Male Stud BSP P&M Branch T Erkek BSP P&M Dağıtım T	Order Number Sipariş Kodu	Size	Boyut
	SM061804	1/8-4	
	SM061806	1/8-6	
	SM061406	1/4-6	
	SM063806	3/8-6	
	SM061808	1/8-8	
	SM061408	1/4-8	
	SM063808	3/8-8	
	SM061410	1/4-10	
	SM063810	3/8-10	
	SM061412	1/4-12	
	SM063812	3/8-12	

Female Stud BSP P&M Dişi Cıvatalı BSP P&M	Order Number Sipariş Kodu	Size	Boyut
	SM081804	1/8-4	
	SM081806	1/8-6	
	SM081406	1/4-6	
	SM083806	3/8-6	
	SM081808	1/8-8	
	SM081408	1/4-8	
	SM083808	3/8-8	
	SM081410	1/4-10	
	SM083810	3/8-10	
	SM081412	1/4-12	
	SM083812	3/8-12	

Order Number Sipariş Kodu	Size	Boyut
-----------------------------	------	-------

Male Stud BSP P&M Erkek Cıvatalı BSP P&M	Order Number Sipariş Kodu	Size	Boyut
	SM01M404	M 4-4	
	SM01M504	M 5-4	
	SM01M604	M 6-4	
	SM011804	1/8-4	
	SM011806	1/8-6	
	SM011406	1/4-6	
	SM013806	3/8-6	
	SM011808	1/8-8	
	SM011408	1/4-8	
	SM013808	3/8-8	
	SM011410	1/4-10	
	SM013810	3/8-10	
	SM011412	1/4-12	
	SM013812	3/8-12	

Male Stud Run Elbow 90° Cıvatalı Erkek 90° Dirsek	Order Number Sipariş Kodu	Size	Boyut
	SM041804	1/8-4	
	SM041806	1/8-6	
	SM041406	1/4-6	
	SM043806	3/8-6	
	SM041808	1/8-8	
	SM041408	1/4-8	
	SM043808	3/8-8	
	SM041410	1/4-10	
	SM043810	3/8-10	
	SM041412	1/4-12	
	SM043812	3/8-12	

Male Stud Run BSP P&M Erkek Cıvatalı Akış BSP P&M	Order Number Sipariş Kodu	Size	Boyut
	SM071804	1/8-4	
	SM071806	1/8-6	
	SM071406	1/4-6	
	SM073806	3/8-6	
	SM071808	1/8-8	
	SM071408	1/4-8	
	SM073808	3/8-8	
	SM071410	1/4-10	
	SM073810	3/8-10	
	SM071412	1/4-12	
	SM073812	3/8-12	

Reducer Redüktör	Order Number Sipariş Kodu	Size	Boyut
	SM090604	06-04	
	SM090806	08-06	
	SM091008	10-08	
	SM091210	12-10	

Male Reducer Erkek Redüktör	Order Number Sipariş Kodu	Size	Boyut
	SM100604	06-04	
	SM100806	08-06	
	SM101008	10-08	
	SM101210	12-10	

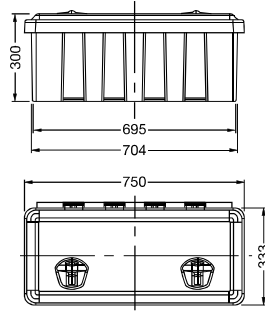

Trailer Tool Box 42 Liters
Dorse Alet Çantası 42 Litre

Order Number
Sipariş Kodu

5512A

1 pc Adet

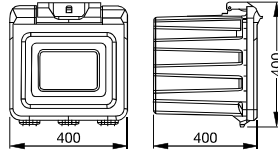

Trailer Tool Box 50 Liters
Dorse Alet Çantası 50 Litre

Order Number
Sipariş Kodu

5507A

5 pcs Adet

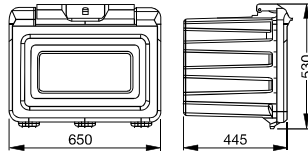

Trailer Tool Box 80 Liters
Dorse Alet Çantası 80 Litre

Order Number
Sipariş Kodu

5504A

4 pcs Adet

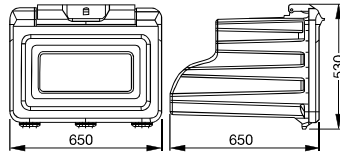

Trailer Tool Box 110 Liters
Dorse Alet Çantası 110 Litre

Order Number
Sipariş Kodu

5503A

3 pcs Adet

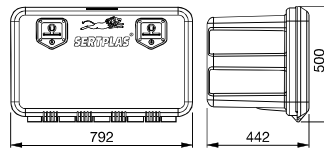

Trailer Tool Box 100 Liters
Dorse Alet Çantası 100 Litre

Order Number
Sipariş Kodu

5500

1 pc Adet



Trailer Wheel Chock

Tır Takozu

Order Number Sipariş Kodu		Without Holder Tutucu olmadan
Complete with Holder Tutucu ile birlikte	Without Holder Tutucu olmadan	Without Holder Tutucu olmadan
5502AB	5502A	5506A
*Wheel Radius (in mm): 530		*Wheel Radius (in mm): 460
6 pcs Adet	6 pcs Adet	6 pcs Adet

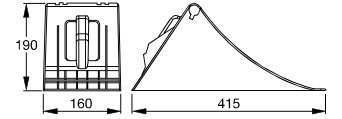
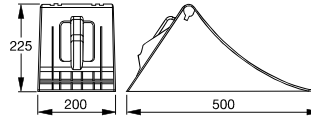

*Wheel Radius (in mm): 530
According to DIN 76051-G53 Z

*Wheel Radius (in mm): 460
According to DIN 76051-G46 Z

Trailer Sliden Fire Extinguisher Box (6 Kilos)

Yangın Söndürme Kutusu (6 Kilo)

Order Number Sipariş Kodu
5518
6 pcs Adet

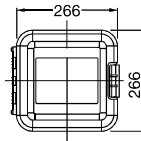
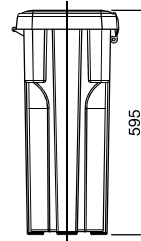

Trailer Fire Extinguisher Box (6 to 9 Kilos)

Yangın Söndürme Kutusu (6 ila 9 Kilo)

Order Number Sipariş Kodu	
With 1 inner Clamp 1 Kıskaçlı	With 2 inner Clamp 2 Kıskaçlı
5501A	5501B
6 pcs Adet	6 pcs Adet



Trailer Fire Extinguisher Box (6 Kilos)

Yangın Söndürme Kutusu (6 Kilo)

Order Number Sipariş Kodu
5510
6 pcs Adet



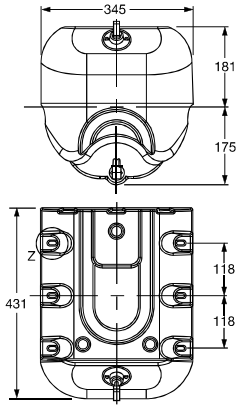

Water Jug 30 Liters
Su Deposu 30 Litre

Order Number
Sipariş Kodu

5505A

6 pcs Adet

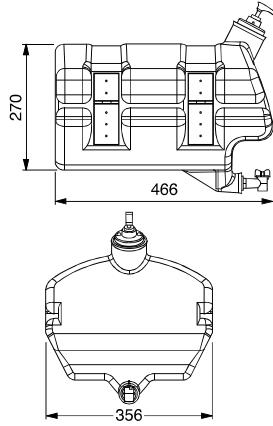

Water Jug 30 Liters
Su Deposu 30 Litre

Order Number
Sipariş Kodu

5511

6 pcs Adet

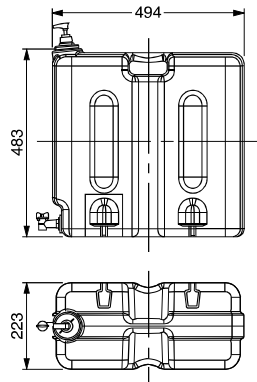

Water Jug 40 Liters
Su Deposu 40 Litre

Order Number
Sipariş Kodu

5514

4 pcs Adet



20 Lt

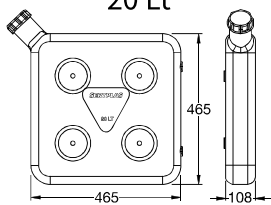

10 Lt

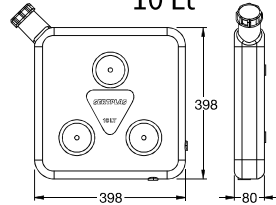

Fuel Tank
Yakıt Deposu

Order Number | Sipariş Kodu

20 Liters | 20 Litre

10 Liters | 10 Litre

5508

5509

10 pcs Adet

15 pcs Adet

Plastic Half-Wing
Plastik Çamurluk

Order Number
Sipariş Kodu

1307

5 pcs Adet

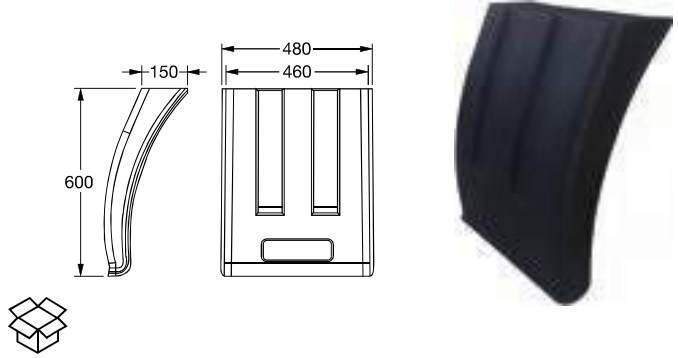

Mudguard (White Strip)
Çamurluk (Beyaz Çizgili)

Order Number | Sipariş Kodu

Mudguard with White Strip
Beyaz Çizgili

Mudguard without White Strip
Beyaz Çizgisiz

1301P

1302P

Different Strip Colours are Available
Reflector Strips are Also Available

5 pcs Adet

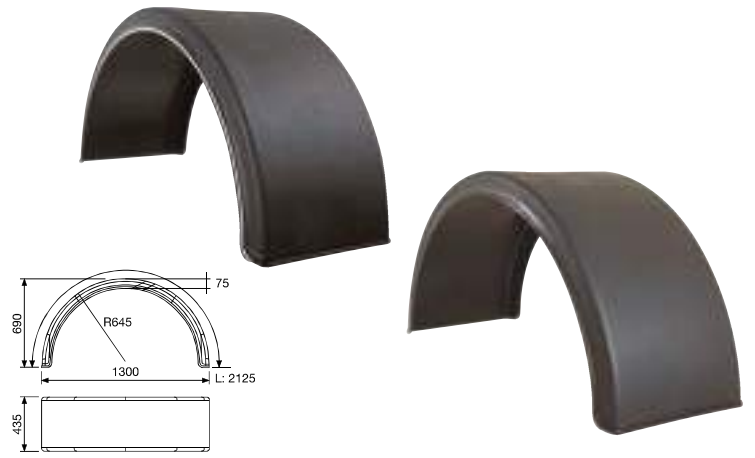

Mudguard (White Strip)
Çamurluk (Beyaz Çizgili)

Order Number | Sipariş Kodu

Mudguard with White Strip
Beyaz Çizgili

Mudguard without White Strip
Beyaz Çizgisiz

1303P

1304P

Different Strip Colours are Available
Reflector Strips are Also Available

5 pcs Adet



Adjustable Support for Mudguard
Çamurluk için Tutucu Destek

Order Number
Sipariş Kodu

2478

50 pcs Adet





Truck / Lorry Warning Board
Tır / Kamyon Uyarı Panosu

Order Number
Sipariş Kodu

9020



Board Size : 560x135 mm

Aluminium Base / Alüminyum Taban



Truck / Trailer Warning Board
Tır / Römork Uyarı Panosu

Order Number
Sipariş Kodu

9019



Board Size : 565x200 mm

Aluminium Base / Alüminyum Taban



Custom Area Warning Board
Gümrük Levhası

Order Number | Sipariş Kodu

With Pocket | Cepli

Without Pocket | Cepsiz

9003.A1

9003.A2

Board Size : 300x200 mm

Heavy Vehicle Load Carrying Warning Board
Ağır Araç Taşıyıcı İkaz Plaketi



Order Number | Sipariş Kodu

Aluminium Base
Alüminyum Taban

Galvanise Base
Galvaniz Taban

9011Q2 350x350 mm
DM9011Q1 423x423 mm

9011 350x350 mm

Shock Absorber for Tail Lamps

Tır Stop Lamba Titreşim Emici Ayağı

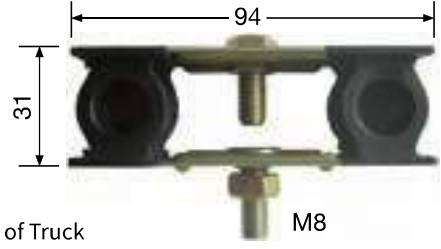
Order Number
Sipariş Kodu**0344A**

Suitable for all Types of Truck

M8

Euro - Countries Sign Plates

Elips TR Plakası

Order Number
Sipariş Kodu**9016**

Flat Printed Mudflaps

Düz Yazılı Paçalık

Order Number | Sipariş Kodu

35x50 mm

40x60 mm

DM990134**DM990135**

* Includes two pieces

Embossed Printed Mudflaps

Kabartma Yazılı Paçalık

Order Number | Sipariş Kodu

30x64 mm

36x64 mm

DM990139**DM990140**

Order Number | Sipariş Kodu

40x45 mm

40x60 mm

DM990138**DM990141**

* Includes two pieces

Flat Printed Mudflaps

Düz Yazılı Paçalık

Order Number | Sipariş Kodu

35x240 mm

DM990136

Embossed Printed Mudflaps

Kabartma Yazılı Paçalık

Order Number | Sipariş Kodu

35x240 mm

990137

WIRING OF SOCKET & PLUGS ACCORDING TO INTERNATIONAL STANDARDS
ISO 1724 12V / 7 pins

Inner View of Plug

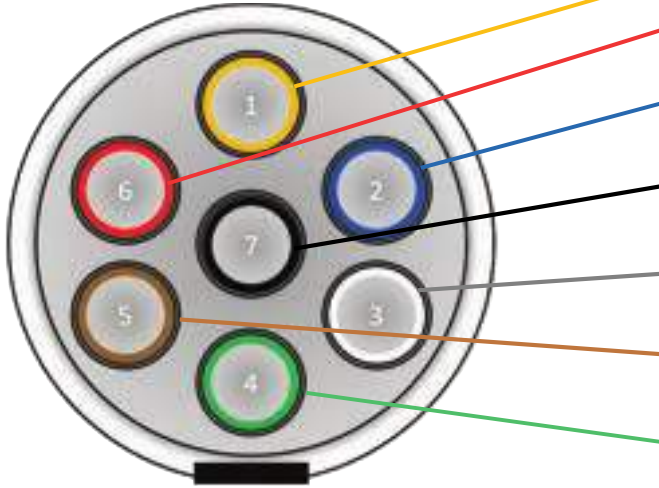

Left-hand direction light | SOL sinyal

Stop lamp | Stop lambası

 +12V from battery Rear fog lamps
Aküden +12V veya Arka sis lambası

 Left-hand rear position and marker lights and rear-
registration-plate illumination device | SOL arka lamba,
pozisyon, işaret lambaları ve plaka aydınlatma

Ground connected to chassis | Toprak şasi bağlantısı

 Right-hand rear position and marker lights and rear-
registration-plate illumination device | SAĞ arka pozisyon,
işaret lambaları ve plaka aydınlatma

Right-hand direction indicator light | SAĞ sinyal

ISO 1185 N type 24V / 7 pins

Inner View of Plug

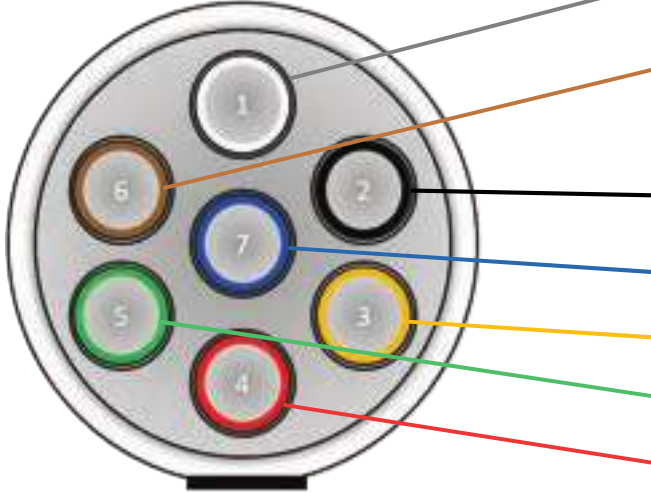

Ground connected to chassis | Toprak Şasi bağlantısı

 Right-hand rear position and marker lights and rear-
registration-plate illumination device | SAĞ arka lamba,
pozisyon, işaret lambaları ve plaka aydınlatma

 Left-hand rear position and marker lights and rear-
registration-plate illumination device | SOL arka lamba,
pozisyon, işaret lambaları ve plaka aydınlatma

Trailer brake control | Treyler fren kontrolü

Left-hand direction indicator light | SOL sinyal

Right-hand direction indicator light | SAĞ sinyal

Stop lamp | Stop lambası

ISO 3731 S type 24V / 7 pins

Inner View of Plug

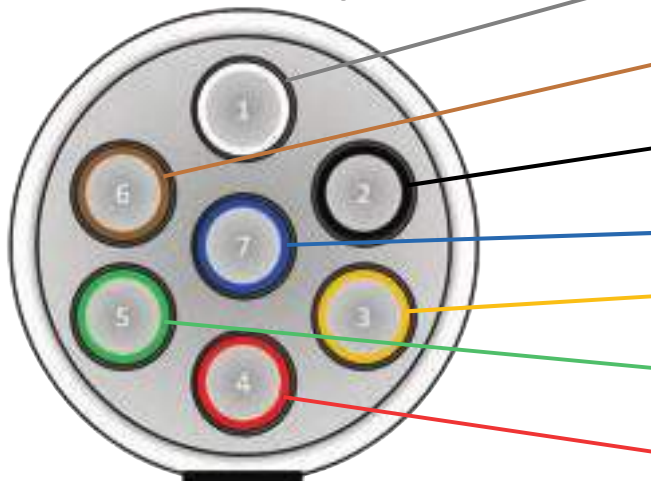

Ground connected to chassis | Toprak Şasi bağlantısı

+24V power supply controlled by ignition switch

Kontak kontrol +24V

 Reversed for future allocation | İhtiyaç duyulabilecek ek
fonksiyonlar için ayrılmış pin

Rear fog lamps | Arka sis lambası

Reversing lamps | Geri vites ışığı

 Sensing device with common return | Sensörler için şase
bağlantısı

+24V Permanent | Sabit +24V

WIRING OF SOCKET & PLUGS ACCORDING TO INTERNATIONAL STANDARDS

ISO 7638-1 EBS 24 Volt 7 Pin

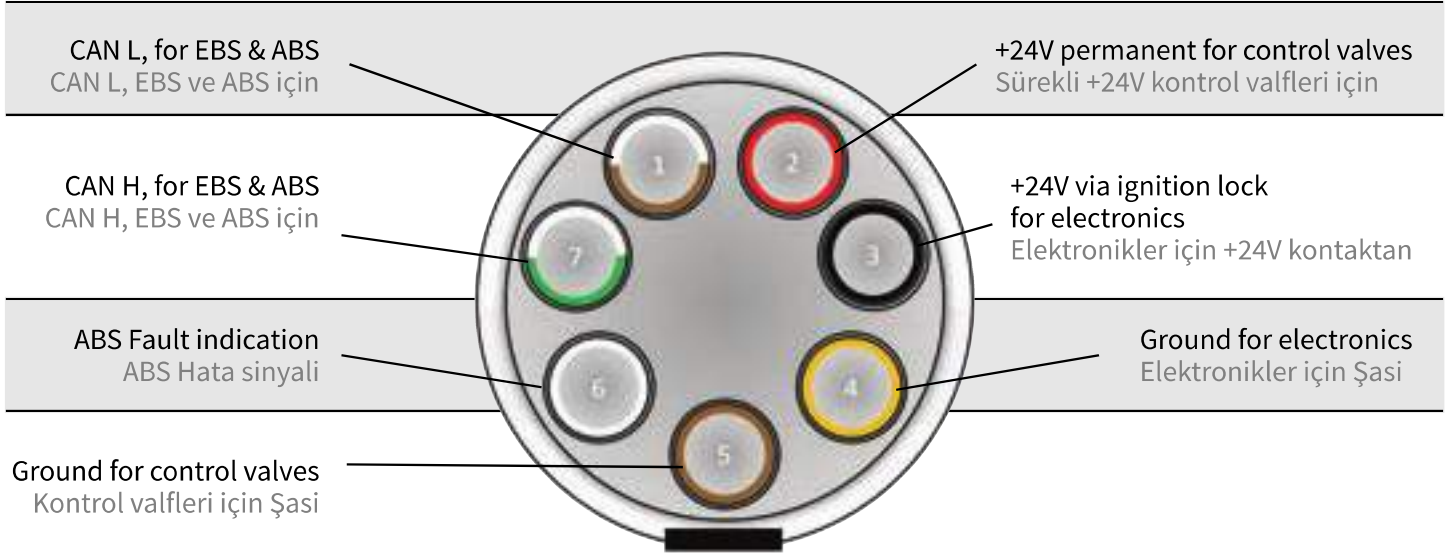

ISO 12098 15-Pin Trailer Connector

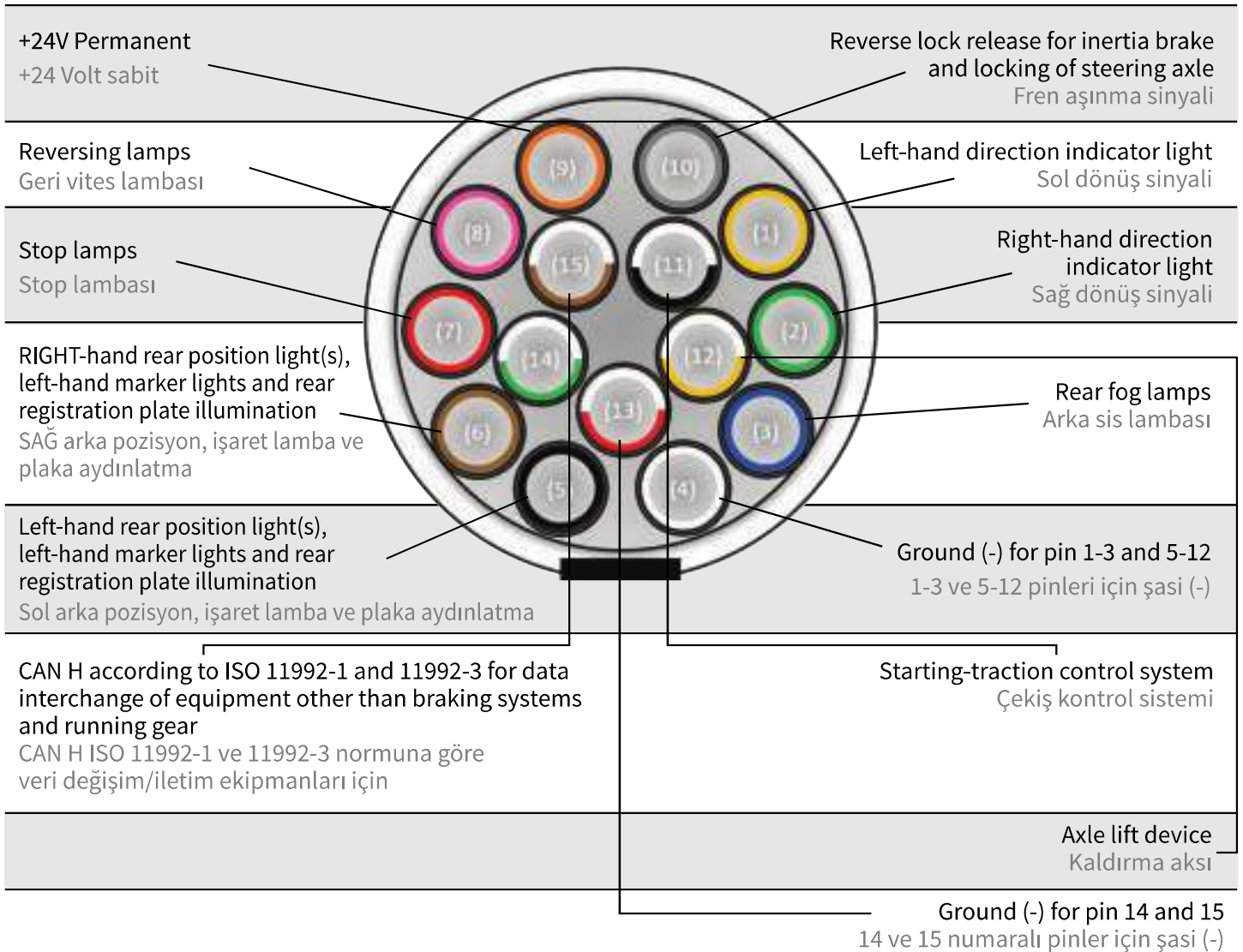

E4205

ABS ELECTRICAL CABLE 5 POLES PLUGS ABS 5 PİNLİ, 2 FİŞLİ ELEKTRİK KABLOSU

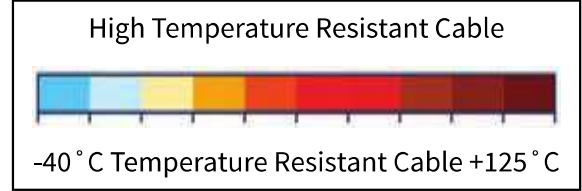
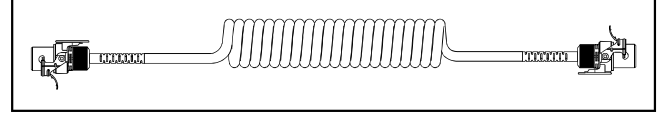
Certificated

- IP69K
- ADR ISO 6722
- ADR ISO 14572
- ISO 7638
- ADR/GGVS

Product Speciality Ürün Özelliği	Electric Braking System Coil Cable	Elektrikli Fren Sistemleri için Spiral Elektrik Kablosu
Voltage Compatability Voltaj Uyumluluğu	24V	24V
Wire Cross-Section mm ² Kablo Kesitleri mm ²	2x4 + 3x1,5	2x4 + 3x1,5
Protection Koruma	IP69K	IP69K
Material Hammadde	TPU	TPE
Temperature Res. Sıcaklık Dayanıklılığı	-40 ° C / +125 ° C	-40 ° C / +125 ° C

Variants Değişenler	Order Number Sipariş Kodu	E4205FH30	E4205FH35	E4205FH40
	Turns / Outer Diameter Sarım Sayısı / Dış Çap	26 / 50 mm	31 / 50 mm	36 / 50 mm
	Max. Working Length Maks. Çalışma Boyu	3,5m	4m	4,5m
		10 pcs Adet		

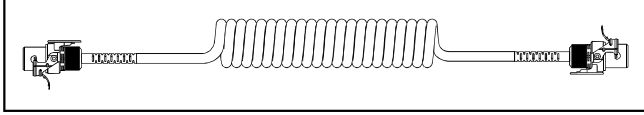
EBS ELECTRICAL CABLE 7 POLES PLUGS
EBS 7 PİNLİ, 2 FİŞLİ ELEKTRİK KABLOSU**E4207**

High Temperature Resistant Cable



-40° C Temperature Resistant Cable +125° C

Certificated

- ✓ IP69K
- ✓ ADR ISO 6722
- ✓ ADR ISO 14572

- ✓ ISO 7638
- ✓ ADR/GGVS

**EURO 6**

Product Speciality Ürün Özelliği	Electric Braking System Coil Cable	Elektrikli Fren Sistemleri için Spiral Elektrik Kablosu
Voltage Compatability Voltaj Uyumluluğu	24V	24V
Wire Cross-Section mm ² Kablo Kesitleri mm ²	2x4 + 5x1,5	2x4 + 5x1,5
Protection Koruma	IP69K	IP69K
Material Hammadde	TPU	TPE
Temperature Res. Sıcaklık Dayanıklılığı	-40° C/ +125° C	-40° C/ +125° C

Variants Değişenler	Order Number Sipariş Kodu	E4207FH30	E4207FH35	E4207FH40
	Turns / Outer Diameter Sarımlar Sayısı / Dış Çap	26 / 50 mm	31 / 50 mm	36 / 50 mm
	Max. Working Length Maks. Çalışma Boyu	3,5m	4m	4,5m
		10 pcs Adet		

E4215

ELECTRICAL CABLE TWO 15 POLES 15 CONNECTION PLUGS 15 PİNLİ, 15 BAĞLANTILI, 2 FİŞLİ ELEKTRİK KABLOSU

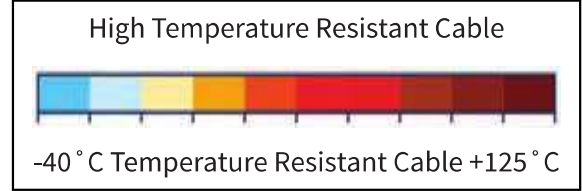
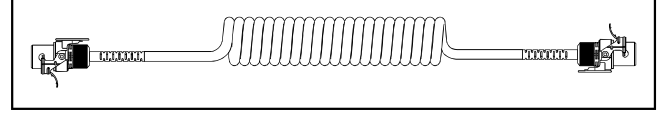
Certificated



- ✓ IP69K
- ✓ ADR ISO 6722
- ✓ ADR ISO 14572
- ✓ ISO 12098
- ✓ ADR/GGVS

Product Speciality Ürün Özelliği	Electric Braking System Coil Cable	Elektrikli Fren Sistemleri için Spiral Elektrik Kablosu
Voltage Compatability Voltaj Uyumluluğu	24V	24V
Wire Cross-Section mm ² Kablo Kesitleri mm ²	3x2,5 + 12x1,5	3x2,5 + 12x1,5
Protection Koruma	IP69K	IP69K
Material Hammadde	TPU	TPE
Temperature Res. Sıcaklık Dayanıklılığı	-40 °C / +125 °C	-40 °C / +125 °C

Variants Değişenler	Order Number Sipariş Kodu	E4215FH30	E4215FH35	E4215FH40
	Turns / Outer Diameter Sarım Sayısı / Dış Çap	19 / 67 mm	22 / 67 mm	25 / 67 mm
	Max. Working Length Maks. Çalışma Boyu	3,5m	4m	4,5m
		8 pcs Adet		

ADAPTER DOUBLE CABLE 15 POLES 13 CONNECTION PLUGS
7 POLES N-TYPE OVER MOLDED PLUG / 7 POLES S-TYPE OVER MOLDED PLUG
15 PİNLİ, 13 BAĞLANTILI, ÇİFT ADAPTÖR KABLOSU
7 PİNLİ N-TİP ENJEKSİYON BASKILI FİŞ/7 PİNLİ S-TİP ENJEKSİYON BASKILI FİŞ

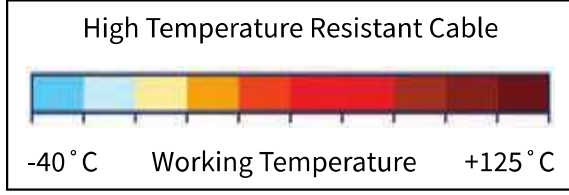
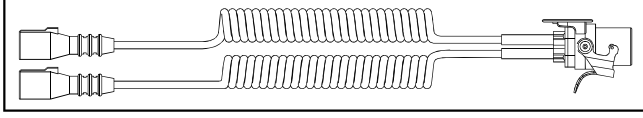
E4415



Certificated

- ✓ IP69K
- ✓ ADR ISO 6722
- ✓ ADR ISO 14572
- ✓ ISO 1185
- ✓ ISO 3731
- ✓ ISO 12098



Product Speciality Ürün Özelliği	Electric Braking System Coil Cable	Elektrikli Fren Sistemleri için Spiral Elektrik Kablosu
Voltage Compatability Voltaj Uyumluluğu	24V	24V
Wire Cross-Section mm ² Kablo Kesitleri mm ²	2(6x1,5 + 1x2,5)	2(6x1,5 + 1x2,5)
Protection Koruma	IP69K	IP69K
Material Hammadde	TPU	TPE
Temperature Res. Sıcaklık Dayanıklılığı	-40° C / +125° C	-40° C / +125° C

Variants Değişenler	Order Number Sipariş Kodu	E4415FH3U30	E4415FH3U35	E4415FH3U40
	Turns / Outer Diameter Sarımlar Sayısı / Dış Çap	27 / 52 mm	34 / 52 mm	38 / 52 mm
	Max. Working Length Maks. Çalışma Boyu	3,5m	4m	4,5m
		10 pcs Adet		

E4205

ABS ELECTRICAL CABLE 5 POLES PLUGS ABS 5 PİNLİ, 2 FİŞLİ ELEKTRİK KABLOSU

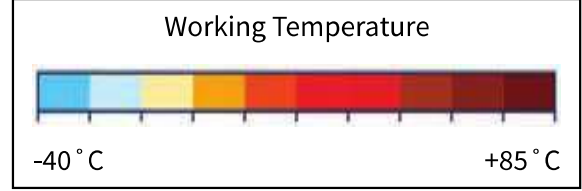
Certificated

- IP69K
- ADR ISO 6722
- ADR ISO 14572
- ISO 7638
- ADR/GGVS

Product Speciality Ürün Özelliği	Electric Braking System Coil Cable	Elektrikli Fren Sistemleri için Spiral Elektrik Kablosu
Voltage Compatability Voltaj Uyumluluğu	24V	24V
Wire Cross-Section mm ² Kablo Kesitleri mm ²	2x4 + 3x1,5	2x4 + 3x1,5
Protection Koruma	IP69K	IP69K
Material Hammadde	TPU	TPU
Temperature Res. Sıcaklık Dayanıklılığı	-40 °C / +85 °C	-40 °C / +85 °C

Variants Değişenler	Order Number Sipariş Kodu	E4205F30	E4205F35	E4205F40
	Turns / Outer Diameter Sarım Sayısı / Dış Çap	26 / 50 mm	31 / 50 mm	36 / 50 mm
	Max. Working Length Maks. Çalışma Boyu	3,5m	4m	4,5m
		15 pcs Adet		

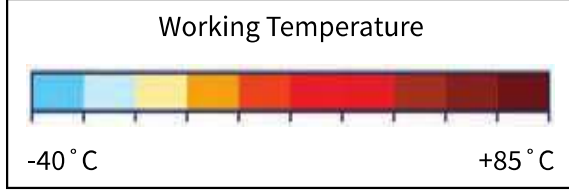
EBS ELECTRICAL CABLE 7 POLES PLUGS
EBS 7 PİNLİ, 2 FİŞLİ ELEKTRİK KABLOSU**E4207**

Certificated

- ✓ IP69K
- ✓ ADR ISO 6722
- ✓ ADR ISO 14572
- ✓ ISO 7638
- ✓ ADR/GGVS



Product Speciality Ürün Özelliği	Electric Braking System Coil Cable	Elektrikli Fren Sistemleri için Spiral Elektrik Kablosu
Voltage Compatability Voltaj Uyumluluğu	24V	24V
Wire Cross-Section mm ² Kablo Kesitleri mm ²	2x4 + 5x1,5	2x4 + 5x1,5
Protection Koruma	IP69K	IP69K
Material Hammadde	TPU	TPU
Temperature Res. Sıcaklık Dayanıklılığı	-40 °C / +85 °C	-40 °C / +85 °C

Variants Değişenler	Order Number Sipariş Kodu	E4207F30	E4207F35	E4207F40
	Turns / Outer Diameter Sarım Sayısı / Dış Çap	26 / 52 mm	31 / 52 mm	36 / 52 mm
	Max. Working Length Maks. Çalışma Boyu	3,5m	4m	4,5m
		15 pcs Adet		

E4215

ELECTRICAL CABLE TWO 15 POLES 15 CONNECTION PLUGS 15 PİNLİ, 15 BAĞLANTILI, 2 FİŞLİ ELEKTRİK KABLOSU

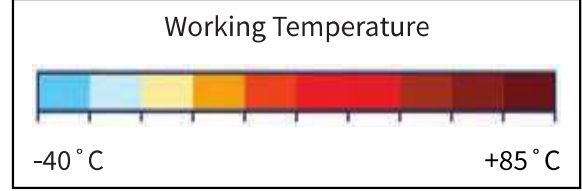

Certificated

- IP69K
- ADR ISO 6722
- ADR ISO 14572
- ISO 12098
- ADR/GGVS

Product Speciality Ürün Özelliği	Electric Braking System Coil Cable	Elektrikli Fren Sistemleri için Spiral Elektrik Kablosu
Voltage Compatability Voltaj Uyumluluğu	24V	24V
Wire Cross-Section mm ² Kablo Kesitleri mm ²	3x2,5 + 12x1,5	3x2,5 + 12x1,5
Protection Koruma	IP69K	IP69K
Material Hammadde	TPU	TPU
Temperature Res. Sıcaklık Dayanıklılığı	-40 °C / +85 °C	-40 °C / +85 °C

Variants Değişenler	Order Number Sipariş Kodu	E4215F30	E4215F35	E4215F40
	Turns / Outer Diameter Sarım Sayısı / Dış Çap	19 / 67 mm	22 / 67 mm	25 / 67 mm
	Max. Working Length Maks. Çalışma Boyu	3,5m	4m	4,5m
		12 pcs Adet		10 pcs Adet

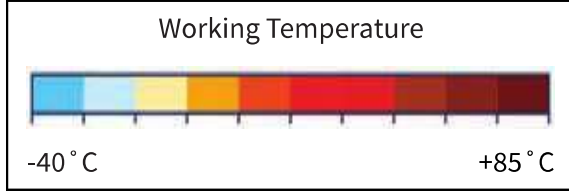
ADAPTER DOUBLE CABLE 15 POLES 13 CONNECTION PLUGS
7 POLES N-TYPE METAL PLUG / 7 POLES S-TYPE METAL PLUG
15 PİNLİ, 13 BAĞLANTILI, ÇİFT ADAPTÖR KABLOSU
7 PİNLİ N-TİP METAL FİŞ / 7 PİNLİ S-TİP METAL FİŞ

E4415**Certificated**

- ✓ IP69K
- ✓ ADR ISO 6722
- ✓ ADR ISO 14572
- ✓ ISO 1185
- ✓ ISO 3731
- ✓ ISO 12098



Product Speciality Ürün Özelliği	Electric Braking System Coil Cable	Elektrikli Fren Sistemleri için Spiral Elektrik Kablosu
Voltage Compatability Voltaj Uyumluluğu	24V	24V
Wire Cross-Section mm ² Kablo Kesitleri mm ²	2(6x1 + 1x1,5)	2(6x1 + 1x1,5)
Protection Koruma	IP69K	IP69K
Material Hammadde	TPU	TPU
Temperature Res. Sıcaklık Dayanıklılığı	-40 °C / +85 °C	-40 °C / +85 °C

Variants Değişenler	Order Number Sipariş Kodu	E4415F3M30	E4415F3M35	E4415F3M40
	Turns / Outer Diameter Sarımlar Sayısı / Dış Çap	27 / 47 mm	33 / 47 mm	38 / 47 mm
	Max. Working Length Maks. Çalışma Boyu	3,5m	4m	4,5m
		15 pcs Adet		

E4415

ADAPTER DOUBLE CABLE 15 POLES 13 CONNECTION PLUGS
7 POLES N-TYPE PLASTIC PLUG / 7 POLES S-TYPE PLASTIC PLUG
15 PİNLİ, 13 BAĞLANTILI, ÇİFT ADAPTÖR KABLOSU
7 PİNLİ N-TİP PLASTİK FİŞ / 7 PİNLİ S-TİP PLASTİK FİŞ

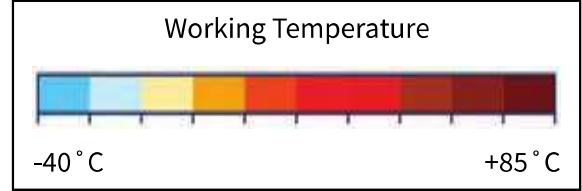

Certificated



IP69K
 ADR ISO 6722
 ADR ISO 14572

ISO 1185
 ISO 3731
 ISO 12098

Product Speciality Ürün Özelliği	Electric Braking System Coil Cable	Elektrikli Fren Sistemleri için Spiral Elektrik Kablosu
Voltage Compatability Voltaj Uyumluluğu	24V	24V
Wire Cross-Section mm ² Kablo Kesitleri mm ²	2(6x1 + 1x1,5)	2(6x1 + 1x1,5)
Protection Koruma	IP69K	IP69K
Material Hammadde	TPU	TPU
Temperature Res. Sıcaklık Dayanıklılığı	-40 °C / +85 °C	-40 °C / +85 °C

Variants Değişenler	Order Number Sipariş Kodu	E4415F3P30	E4415F3P35	E4415F3P40
	Turns / Outer Diameter Sarım Sayısı / Dış Çap	27 / 47 mm	33 / 47 mm	38 / 47 mm
	Max. Working Length Maks. Çalışma Boyu	3,5m	4m	4,5m
		15 pcs Adet		

ADAPTER DOUBLE CABLE 15 POLES 13 CONNECTION PLUGS
7 POLES N-TYPE OVER MOLDED PLUG / 7 POLES S-TYPE OVER MOLDED PLUG
15 PİNLİ, 13 BAĞLANTILI, ÇİFT ADAPTÖR KABLOSU
7 PİNLİ N-TİP ENJEKSİYON BASKILI FİŞ/7 PİNLİ S-TİP ENJEKSİYON BASKILI FİŞ

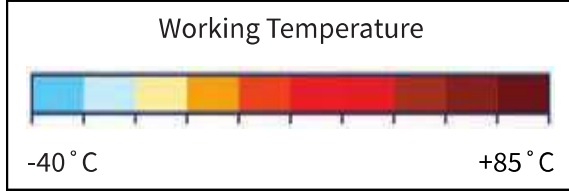
E4415**Certificated**

- ✓ IP69K
- ✓ ADR ISO 6722
- ✓ ADR ISO 14572
- ✓ ISO 1185
- ✓ ISO 3731
- ✓ ISO 12098



Product Speciality Ürün Özelliği	Electric Braking System Coil Cable	Elektrikli Fren Sistemleri için Spiral Elektrik Kablosu
Voltage Compatability Voltaj Uyumluluğu	24V	24V
Wire Cross-Section mm ² Kablo Kesitleri mm ²	2(6x1 + 1x1,5)	2(6x1 + 1x1,5)
Protection Koruma	IP69K	IP69K
Material Hammadde	TPU	TPU
Temperature Res. Sıcaklık Dayanıklılığı	-40 °C / +85 °C	-40 °C / +85 °C

Variants Değişenler	Order Number Sipariş Kodu	E4415F3U30	E4415F3U35	E4415F3U40
	Turns / Outer Diameter Sarımlar Sayısı / Dış Çap	27 / 47 mm	33 / 47 mm	38 / 47 mm
	Max. Working Length Maks. Çalışma Boyu	3,5m	4m	4,5m
		15 pcs Adet		

E4415

ADAPTER DOUBLE CABLE 15 POLES 9 CONNECTION PLUGS
7 POLES N-TYPE PLASTIC PLUG / 7 POLES S-TYPE PLASTIC PLUG
15 PİNLİ, 9 BAĞLANTILI, ÇİFT ADAPTÖR KABLOSU
7 PİNLİ N-TİP PLASTİK FİŞ / 7 PİNLİ S-TİP PLASTİK FİŞ

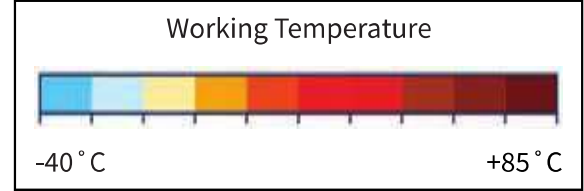

Certificated



- ✓ IP69K
- ✓ ADR ISO 6722
- ✓ ADR ISO 14572
- ✓ ISO 1185
- ✓ ISO 3731
- ✓ ISO 12098

Product Speciality Ürün Özelliği	Electric Braking System Coil Cable	Elektrikli Fren Sistemleri için Spiral Elektrik Kablosu
Voltage Compatability Voltaj Uyumluluğu	24V	24V
Wire Cross-Section mm ² Kablo Kesitleri mm ²	2(6x1 + 1x1,5)	2(6x1 + 1x1,5)
Protection Koruma	IP69K	IP69K
Material Hammadde	TPU	TPU
Temperature Res. Sıcaklık Dayanıklılığı	-40 °C / +85 °C	-40 °C / +85 °C

Variants Değişenler	Order Number Sipariş Kodu	E4415F9P30	E4415F9P35	E4415F9P40
	Turns / Outer Diameter Sarım Sayısı / Dış Çap	27 / 47 mm	33 / 47 mm	38 / 47 mm
	Max. Working Length Maks. Çalışma Boyu	3,5m	4m	4,5m
		15 pcs Adet		

ADAPTER DOUBLE CABLE 15 POLES 9 CONNECTION PLUGS
7 POLES N-TYPE OVER MOLDED PLUG / 7 POLES S-TYPE OVER MOLDED PLUG
15 PİNLİ, 9 BAĞLANTILI, ÇİFT ADAPTÖR KABLOSU
7 PİNLİ N-TİP ENJEKSİYON BASKILI FİŞ/7 PİNLİ S-TİP ENJEKSİYON BASKILI FİŞ

E4415

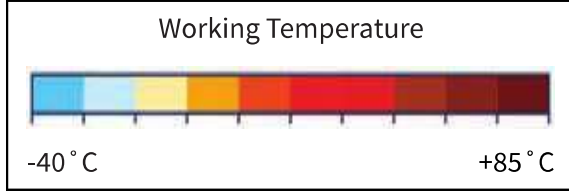

Certificated

- ✓ IP69K
- ✓ ADR ISO 6722
- ✓ ADR ISO 14572
- ✓ ISO 1185
- ✓ ISO 3731
- ✓ ISO 12098



Product Speciality Ürün Özelliği	Electric Braking System Coil Cable	Elektrikli Fren Sistemleri için Spiral Elektrik Kablosu
Voltage Compatability Voltaj Uyumluluğu	24V	24V
Wire Cross-Section mm ² Kablo Kesitleri mm ²	2(6x1 + 1x1,5)	2(6x1 + 1x1,5)
Protection Koruma	IP69K	IP69K
Material Hammadde	TPU	TPU
Temperature Res. Sıcaklık Dayanıklılığı	-40 °C / +85 °C	-40 °C / +85 °C

Variants Değişenler	Order Number Sipariş Kodu	E4415F9U30	E4415F9U35	E4415F9U40
	Turns / Outer Diameter Sarımlar Sayısı / Dış Çap	27 / 47 mm	33 / 47 mm	38 / 47 mm
	Max. Working Length Maks. Çalışma Boyu	3,5m	4m	4,5m
		15 pcs Adet		

E4415

ADAPTER DOUBLE CABLE 15 POLES 9 CONNECTION PLUGS
7 POLES N-TYPE METAL PLUG / 7 POLES S-TYPE METAL PLUG
15 PİNLİ, 9 BAĞLANTILI, ÇİFT ADAPTÖR KABLOSU
7 PİNLİ N-TİP METAL FİŞ / 7 PİNLİ S-TİP METAL FİŞ

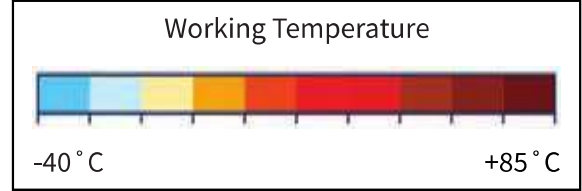
Certificated

- ✓ IP69K
- ✓ ADR ISO 6722
- ✓ ADR ISO 14572
- ✓ ISO 1185
- ✓ ISO 3731
- ✓ ISO 12098

Product Speciality Ürün Özelliği	Electric Braking System Coil Cable	Elektrikli Fren Sistemleri için Spiral Elektrik Kablosu
Voltage Compatability Voltaj Uyumluluğu	24V	24V
Wire Cross-Section mm ² Kablo Kesitleri mm ²	2(6x1 + 1x1,5)	2(6x1 + 1x1,5)
Protection Koruma	IP69K	IP69K
Material Hammadde	TPU	TPU
Temperature Res. Sıcaklık Dayanıklılığı	-40 °C / +85 °C	-40 °C / +85 °C

Variants Değişenler	Order Number Sipariş Kodu	E4415F9M30	E4415F9M35	E4415F9M40
	Turns / Outer Diameter Sarım Sayısı / Dış Çap	27 / 47 mm	33 / 47 mm	38 / 47 mm
	Max. Working Length Maks. Çalışma Boyu	3,5m	4m	4,5m
		15 pcs Adet		

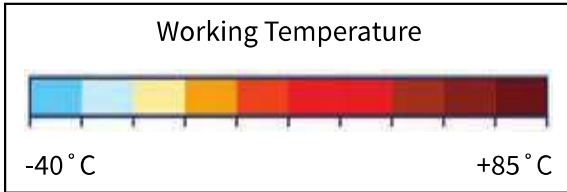
ELECTRICAL CABLE WITH 7 POLES PLUG (24V) N/S-TYPE
7 PİNLİ, İKİ PLASTİK FİŞLİ N/S-TİP (24V) ELEKTRİK KABLOSU**E3853****Certificated**

- ✓ ADR ISO 6722
- ✓ ISO 3731
- ✓ ADR ISO 14572
- ✓ ISO 1185

Product Speciality Ürün Özelliği	Electric Braking System Coil Cable	Elektrikli Fren Sistemleri için Spiral Elektrik Kablosu
Voltage Compatability Voltaj Uyumluluğu	24V	24V
Wire Cross-Section mm ² Kablo Kesitleri mm ²	6x1 + 1x1,5	6x1 + 1x1,5
Material Hammadde	TPU	TPU
Temperature Res. Sıcaklık Dayanıklılığı	-40 °C / +85 °C	-40 °C / +85 °C

Variants Değişenler	Order Number Sipariş Kodu	N Type N Tip S Type S Tip	EN3853FP30 ES3853FP30	EN3853FP35 ES3853FP35	EN3853FP40 ES3853FP40
	Turns / Outer Diameter Sarım Sayısı / Dış Çap		27 / 47 mm	33 / 47 mm	38 / 47 mm
	Max. Working Length Maks. Çalışma Boyu		3,5m	4m	4,5m
			30 pcs Adet		25 pcs Adet

E3853

ELECTRICAL CABLE WITH 7 POLES OVER MOLDED PLASTIC PLUG
(24V) N/S TYPE

7 PİNLİ, ENJEKSİYON BASKILI, İKİ FİŞLİ ELEKTRİK KABLOSU
N/S TİP (24V)

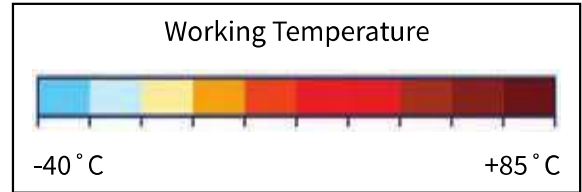

Certificated

✓ ADR ISO 6722

✓ ADR ISO 14572

✓ ISO 1185

✓ ISO 3731

Product Speciality Ürün Özelliği	Electric Braking System Coil Cable	Elektrikli Fren Sistemleri için Spiral Elektrik Kablosu
Voltage Compatability Voltaj Uyumluluğu	24V	24V
Wire Cross-Section mm ² Kablo Kesitleri mm ²	6x1 + 1x1,5	6x1 + 1x1,5
Material Hammadde	TPU	TPU
Temperature Res. Sıcaklık Dayanıklılığı	-40 °C / +85 °C	-40 °C / +85 °C

Variants Değişenler	Order Number Sipariş Kodu	N Type N Tip S Type S Tip	EN3853FU30 ES3853FU30	EN3853FU35 ES3853FU35	EN3853FU40 ES3853FU40
	Turns / Outer Diameter Sarımlar Sayısı / Dış Çap		27 / 47 mm	33 / 47 mm	38 / 47 mm
	Max. Working Length Maks. Çalışma Boyu		3,5m	4m	4,5m
			30 pcs Adet		25 pcs Adet

ELECTRICAL CABLE WITH 7 POLES METAL PLUG (24V) N/S TYPE
7 PİNLİ, 2 METAL FİŞLİ N/S TİP (24V) ELEKTRİK KABLOSU

E3853

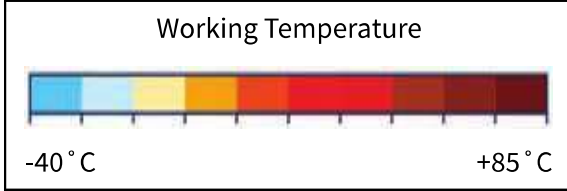

Certificated

- ADR ISO 6722 ISO 3731
 ADR ISO 14572 ISO 1185

Product Speciality Ürün Özelliği	Electric Braking System Coil Cable	Elektrikli Fren Sistemleri için Spiral Elektrik Kablosu
Voltage Compatability Voltaj Uyumluluğu	24V	24V
Wire Cross-Section mm ² Kablo Kesitleri mm ²	6x1 + 1x1,5	6x1 + 1x1,5
Material Hammadde	TPU	TPU
Temperature Res. Sıcaklık Dayanıklılığı	-40 °C / +85 °C	-40 °C / +85 °C

Variants Değişenler	Order Number Sipariş Kodu	N Type N Tip S Type S Tip	EN3853FM30 ES3853FM30	EN3853FM35 ES3853FM35	EN3853FM40 ES3853FM40
	Turns / Outer Diameter Sarımlar Sayısı / Dış Çap		27 / 47 mm	33 / 47 mm	38 / 47 mm
	Max. Working Length Maks. Çalışma Boyu		3,5m	4m	4,5m
			30 pcs Adet		25 pcs Adet

E3853

ELECTRICAL CABLE WITH 7 POLES METAL PLUG (24V) N/S TYPE
7 PİNLİ, 2 METAL FİŞLİ N/S TİP (24V) ELEKTRİK KABLOSU

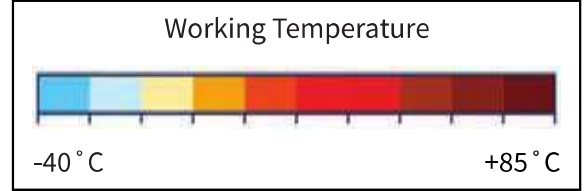

Certificated

- ADR ISO 6722
- ADR ISO 14572
- ISO 3731
- ISO 1185

Product Speciality Ürün Özelliği	Electric Braking System Coil Cable	Elektrikli Fren Sistemleri için Spiral Elektrik Kablosu
Voltage Compatability Voltaj Uyumluluğu	24V	24V
Wire Cross-Section mm ² Kablo Kesitleri mm ²	6x1 + 1x1,5	6x1 + 1x1,5
Material Hammadde	TPU	TPU
Temperature Res. Sıcaklık Dayanıklılığı	-40 °C / +85 °C	-40 °C / +85 °C

Variants Değişenler	Order Number Sipariş Kodu	N Type N Tip S Type S Tip	EN3853FWM30 ES3853FWM30	EN3853FWM35 ES3853FWM35	EN3853FWM40 ES3853FWM40
	Turns / Outer Diameter Sarımlar Sayısı / Dış Çap		27 / 47 mm	33 / 47 mm	38 / 47 mm
	Max. Working Length Maks. Çalışma Boyu		3,5m	4m	4,5m
			30 pcs Adet		25 pcs Adet

ELECTRICAL CABLE WITH 7 POLES METAL DUST SEALED PLUG (12V)
7 PİNLİ, TOZ KORUMA LASTİKLİ, 2 METAL FİŞLİ ELEKTRİK KABLOSU (12V)

E3863

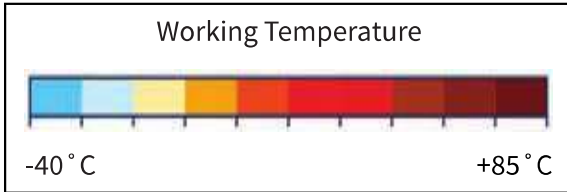

Certificated

- ADR ISO 6722 ISO 1724
 ADR ISO 14572

Product Speciality Ürün Özelliği	Electric Braking System Coil Cable	Elektrikli Fren Sistemleri için Spiral Elektrik Kablosu
Voltage Compatability Voltaj Uyumluluğu	12V	12V
Wire Cross-Section mm ² Kablo Kesitleri mm ²	6x1 + 1x1,5	6x1 + 1x1,5
Material Hammadde	TPU	TPU
Temperature Res. Sıcaklık Dayanıklılığı	-40 °C / +85 °C	-40 °C / +85 °C

Variants Değişenler	Order Number Sipariş Kodu	E3863FM30	E3863FM35	E3863FM40
	Turns / Outer Diameter Sarımlar Sayısı / Dış Çap	27 / 47 mm	33 / 47 mm	38 / 47 mm
	Max. Working Length Maks. Çalışma Boyu	3,5m	4m	4,5m
		30 pcs Adet		25 pcs Adet

E3863

ELECTRICAL CABLE WITH 7 POLES PLASTIC PLUG (12V)
7 PİNLİ, 2 PLASTİK FİŞLİ ELEKTRİK KABLOSU (12V)

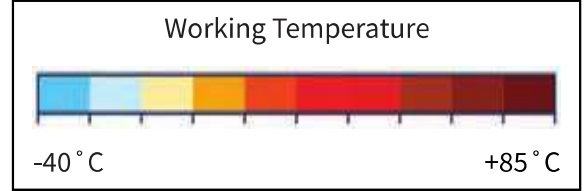
Certificated
 ADR ISO 6722

 ISO 1724

 ADR ISO 14572

Product Speciality Ürün Özelliği	Electric Braking System Coil Cable	Elektrikli Fren Sistemleri için Spiral Elektrik Kablosu
Voltage Compatability Voltaj Uyumluluğu	12V	12V
Wire Cross-Section mm ² Kablo Kesitleri mm ²	6x1 + 1x1,5	6x1 + 1x1,5
Material Hammadde	TPU	TPU
Temperature Res. Sıcaklık Dayanıklılığı	-40 °C / +85 °C	-40 °C / +85 °C

Variants Değişenler	Order Number Sipariş Kodu	E3863FP30	E3863FP35	E3863FP40
	Turns / Outer Diameter Sarım Sayısı / Dış Çap	27 / 47 mm	33 / 47 mm	38 / 47 mm
	Max. Working Length Maks. Çalışma Boyu	3,5m	4m	4,5m
		30 pcs Adet		25 pcs Adet

ELECTRICAL CABLE WITH 7 POLES OVER MOLDED PLUG (12V)
7 PİNLİ, TOZ KORUMA LASTİKLİ, ÜSTÜNE BASKI FİŞLİ
ELEKTRİK KABLOSU (12V)

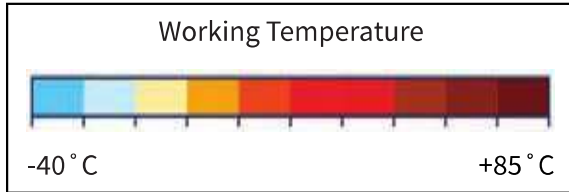





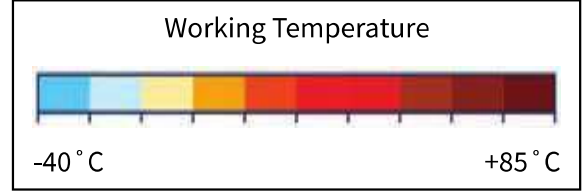

E3863**Certificated**

- ADR ISO 6722
- ISO 1724
- ADR ISO 14572

Product Speciality Ürün Özelliği	Electric Braking System Coil Cable	Elektrikli Fren Sistemleri için Spiral Elektrik Kablosu
Voltage Compatability Voltaj Uyumluluğu	12V	12V
Wire Cross-Section mm ² Kablo Kesitleri mm ²	6x1 + 1x1,5	6x1 + 1x1,5
Material Hammadde	TPU	TPU
Temperature Res. Sıcaklık Dayanıklılığı	-40 °C / +85 °C	-40 °C / +85 °C

Variants Değişenler	Order Number Sipariş Kodu	E3863FU30	E3863FU35	E3863FU40
	Turns / Outer Diameter Sarım Sayısı / Dış Çap	27 / 47 mm	33 / 47 mm	38 / 47 mm
	Max. Working Length Maks. Çalışma Boyu	3,5m	4m	4,5m
		30 pcs Adet		25 pcs Adet

7 POLE ECONOMIC ELECTRICAL CABLE 24V S-TYPE
7 PİNLİ EKONOMİK ELEKTRİK KABLOSU 24V S-TİP
ISO 3731

Voltage Compatability Voltaj Uyumluluğu		24 / 24V
Material Hammadde		PE
Turns / Outer Diameter Sarım Sayısı / Dış Çap		20 / 86 mm
Max. Working Length Maks. Çalışma Boyu		4,2 m
Wire Cross-Section mm ² Kablo Kesitleri mm ²		6x1 + 1x1,5
Variants Değişenler		Order Number Sipariş Kodu
With Plastic Plug Plastik Fişli		ES3811FGP
With Metal Plug Metal Fişli		ES3811FKG
Without Plug Fişsiz		E3812FG
With Plastic Plug Plastik Fişli		ES3811FZP
With Metal Plug Metal Fişli		ES3811FKZ
Without Plug Fişsiz		E3812FZ
With Plastic Plug Plastik Fişli		ES3813FYQ02P
With Metal Plug Metal Fişli		ES3813FQ02
Without Plug Fişsiz		E3812FY

7 POLE STANDART TYPE, WITH METAL PLUG ELECTRICAL SPIRAL CABLE
(24V) N/S TYPE



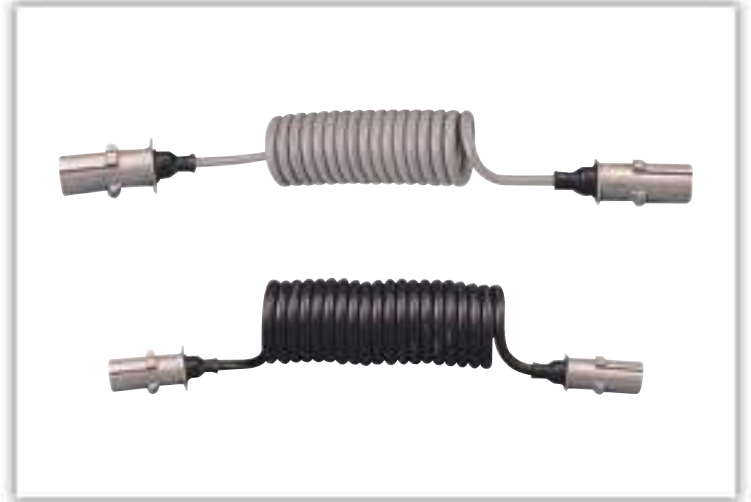
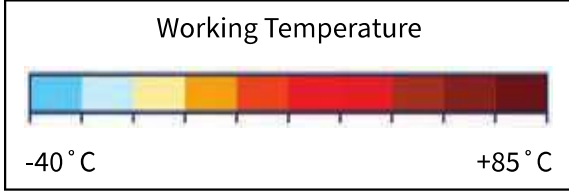



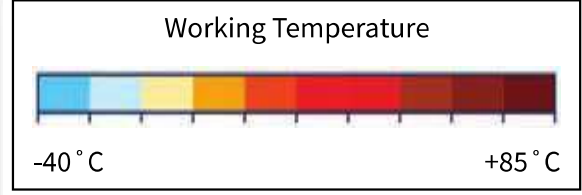

7 PİNLİ, STANDART TİP, METAL FİŞLİ SİRİAL ELEKTRİK KABLOSU
N/S TİP (24V)



Product Speciality Ürün Özelliği	Electric Braking System Coil Cable	Elektrikli Fren Sistemleri için Spiral Elektrik Kablosu
Voltage Compatability Voltaj Uyumluluğu	24 / 24V	24 / 24V
Material Hammadde	PE	PE
Temperature Res. Sıcaklık Dayanıklılığı	-40 ° C / +85 ° C	-40 ° C / +85 ° C

		Order Number Sipariş Kodu		
Variants Değişenler	N Type N Tip S Type S Tip	EN3811F ES3811F	EN3813F ES3813F	EN3809F ES3809F
	Turns / Outer Diameter Sarım Sayısı / Dış Çap	20 / 86 mm	20 / 86 mm	20 / 86 mm
	Max. Working Length Maks. Çalışma Boyu	4,2m	4,2m	4,2m
	Wire Cross-Section mm ² Kablo Kesitleri mm ²	6x1 + 1x1,5	6x0,75 + 1x1	6x0,50 + 1x0,75
		20 pcs Adet		

7 POLE ECONOMIC ELECTRICAL CABLE 24V N-TYPE
7 PİNLİ EKONOMİK ELEKTRİK KABLOSU 24V N-TİP
ISO 1185

Voltage Compatability Voltaj Uyumluluğu		24 / 24V
Material Hammadde		PE
Turns / Outer Diameter Sarım Sayısı / Dış Çap		20 / 86 mm
Max. Working Length Maks. Çalışma Boyu		4,2 m
Wire Cross-Section mm ² Kablo Kesitleri mm ²		6x1 + 1x1,5
Variants Değişenler		Order Number Sipariş Kodu
With Plastic Plug Plastik Fişli		EN3811FGP
With Metal Plug Metal Fişli		EN3811FKG
Without Plug Fişsiz		E3812FG
With Plastic Plug Plastik Fişli		EN3811FZP
With Metal Plug Metal Fişli		EN3811FKZ
Without Plug Fişsiz		E3812FZ
With Plastic Plug Plastik Fişli		EN3813FZQ02P
With Metal Plug Metal Fişli		EN3813FZQ02
Without Plug Fişsiz		E3812FY

7 POLE STANDART TYPE, WITH PLASTIC PLUG P.E. ELECTRICAL SPIRAL CABLE
(24V)

7 PİNLİ, STANDART TİP, PLASTİK FİŞLİ SİRAL ELEKTRİK KABLOSU (24V)

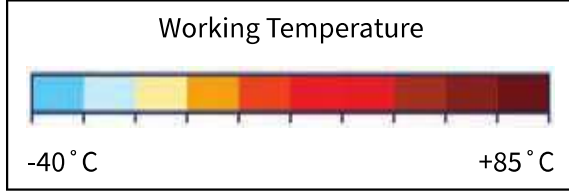

Product Speciality Ürün Özelliği	Electric Braking System Coil Cable	Elektrikli Fren Sistemleri için Siral Elektrik Kablosu
Voltage Compatability Voltaj Uyumluluğu	24 / 24V	24 / 24V
Material Hammadde	PE	PE
Temperature Res. Sıcaklık Dayanıklılığı	-40 ° C / +85 ° C	-40 ° C / +85 ° C

		Order Number Sipariş Kodu		
Variants Değişenler	N Type N Tip S Type S Tip	EN3811FP ES3812FP	EN3813FP ES3857FP	EN3809FP ES3809FP
	Turns / Outer Diameter Sarım Sayısı / Dış Çap	20 / 86 mm	20 / 86 mm	20 / 86 mm
	Max. Working Length Maks. Çalışma Boyu	4,2m	4,2m	4,2m
	Wire Cross-Section mm ² Kablo Kesitleri mm ²	6x1 + 1x1,5	6x0,75 + 1x1	6x0,50 + 1x0,75
		20 pcs Adet		

3834 / 3832

7 POLES ELECTRICAL CABLE 7 PİNLİ ELEKTRİK KABLOSU

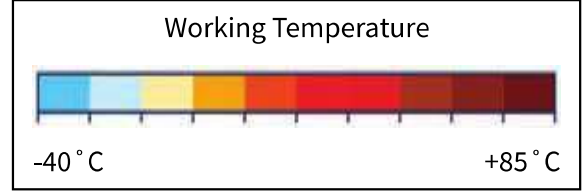

Certificated

- ISO 6722
- ISO 1724

Product Speciality Ürün Özelliği	Electric Braking System Cable	Elektrikli Fren Sistemleri için Elektrik Kablosu
Wire Cross-Section mm ² Kablo Kesitleri mm ²	6x1 + 1x1,5	6x1 + 1x1,5
Material Hammadde	PVC	PVC
Temperature Res. Sıcaklık Dayanıklılığı	-40 °C / +85 °C	-40 °C / +85 °C

Variants Değişenler	Order Number Sipariş Kodu	EN3834F	ES3834F	E3832F
	Voltage Compatability Voltaj Uyumluluğu	24 / 24V	24 / 24V	12 / 12V
	Max. Working Length Maks. Çalışma Boyu	3m	3m	3m
		25 pcs Adet		

Adapter | Adaptör

15 Pole 24V Socket ISO 12098 >
2x7 Pole (N&S Type) ISO 1185 ISO 3731
15 Pinli 24V Soket > 2x7 Pinli (N&S Tip)

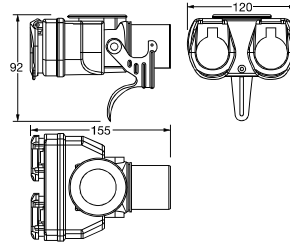

Order Number
Sipariş Kodu

E4017

30 pcs Adet



Plug with Screw / Crimp Pins
Fiş Vidalı / Sıkmalı Pinli



ISO 7638
ISO 12098
IP69K



With Crimp Contact Pins
Sıkmalı Pinli

With Screw Contact Pins
Vidalı Pinli

5 Pin Plug | 5 Pinli Fiş

E4005FQ1

E4005FQ1/FK

7 Pin Plug | 7 Pinli Fiş

E4007FQ1

E4007FQ1/FK

9 Pin Plug | 9 Pinli Fiş

E4009FQ1

E4009FQ1/FK

13 Pin Plug | 13 Pinli Fiş

E4013FQ1

E4013FQ1/FK

15 Pin Plug | 15 Pinli Fiş

E4015FQ1

E4015FQ1/FK



40 pcs Adet

Socket with Screw / Crimp Pins
Soket Vidalı / Sıkmalı Pinli



ISO 7638
ISO 12098
IP69K



With Crimp Contact Pins
Sıkmalı Pinli

With Screw Contact Pins
Vidalı Pinli

5 Pin Socket | 5 Pinli Soket

E4705FQ1

E4705FQ1/FK

7 Pin Socket | 7 Pinli Soket

E4707FQ1

E4707FQ1/FK

9 Pin Socket | 9 Pinli Soket

E4709FQ1

E4709FQ1/FK

13 Pin Socket | 13 Pinli Soket

E4713FQ1

E4713FQ1/FK

15 Pin Socket | 15 Pinli Soket

E4715FQ1

E4715FQ1/FK



40 pcs Adet

Park Socket
Park Soket

Order Number
Sipariş Kodu

2617

40 pcs Adet



ISO 12098



 ISO 3731 ISO 1185			Socket Soket		Plug Fiş	
	Socket Soket	Plug Fiş	Screw Connection Vidalı	Terminal Connection Terminalli	Screw Connection Vidalı	Terminal Connection Terminalli
 Metal Body N Type 7 Pin 24V N Tipi 7 Pinli 24V			EN3817FK	EN3817FF	EN3815FK	EN3815FF
 Metal Body S Type 7 Pin 24V S Tipi 7 Pinli 24V			ES3817FK	ES3817FF	ES3815FK	ES3815FF
 Plastic Body N Type 7 Pin 24V N Tipi 7 Pinli 24V			EN4817FK	EN4817FF	EN3816FK	EN3816FF
 Plastic Body S Type 7 Pin 24V S Tipi 7 Pinli 24V			ES4817FK	ES4817FF	ES3816FK	ES3816FF



	For Crimp Conn.	For Screw Conn.
1,5~2,5 mm ² Pins for Plug Fişler için 1,5~2,5 mm ² Pinler	QKVABS15 Length: 3,4 cm	QKV100S Length: 4,8 cm
4~6 mm ² Pins for Plug Fişler için 4~6 mm ² Pinler	QKVABS40 Length: 3,4 cm	QKV101S Length: 3,6 cm
1,5~2,5 mm ² Pins for Socket Soketler için 1,5~2,5 mm ² Pinler	QKP96 Length: 3,6 cm	QKP100K Length: 5,6 cm
4~6 mm ² Pins for Socket Soketler için 4~6 mm ² Pinler	QKP97 Length: 3,6 cm	QKP101K Length: 4,4 cm

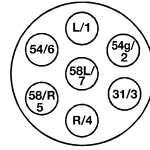

Socket | Soket

Plug | Fiş

7 Pole Socket&Plug 12V Aluminium Housing
7 Pinli Alüminyum Fiş&Soket 12V



ISO 1724

Order Number | Sipariş Kodu

Socket | Soket

Plug | Fiş

E2318FK

E2317FK



100 pcs Adet

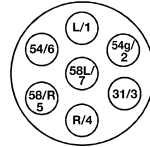

Socket | Soket

Plug | Fiş

7 Pole Socket&Plug 12V Plastic Housing
7 Pinli Plastik Fiş&Soket 12V



ISO 1724

Order Number | Sipariş Kodu

Socket | Soket

Plug | Fiş

E3827FK

E3826FK



100 pcs Adet



Socket | Soket



Plug | Fiş

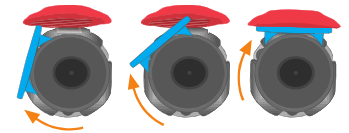

Easy Opening&Locking Operation By Rotating

13Pin 12V Plug/Socket with Screw Terminals for 7-13 Core Cables
13 Pinli 12V Fiş/Soket Vidalı Terminalli 7-13 Damarlı Kablolar için



ISO 11446

Socket | Soket

Order Number | Sipariş Kodu

Plug | Fiş

E2313



100 pcs Adet

E2310 7 Pole | Pin

E2314 13 Pole | Pin

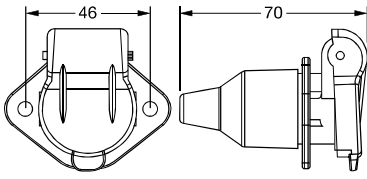

Socket | Soket

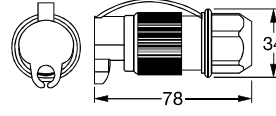

Plug | Fiş

3 Pin6-24V Plug / Socket | 3 Pin 6-24V Fiş / Soket

DIN 9680

Socket Soket	Order Number Sipariş Kodu	Plug Fiş
E4704	 250 pcs Adet	E2320

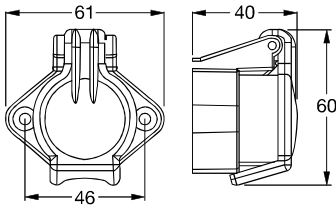

Socket | Soket

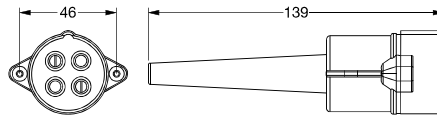

Plug | Fiş

4 Pin6-24V Plug / Socket | 4 Pin 6-24V Fiş / Soket

DIN 72575

Socket Soket	Order Number Sipariş Kodu	Plug Fiş
E3830	 200 pcs Adet	E3828

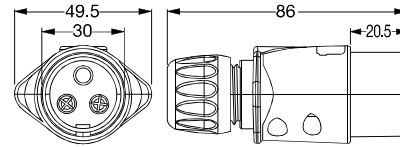
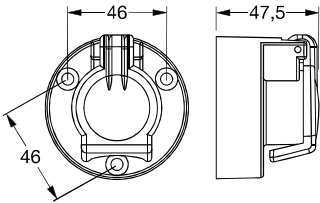

3 Pin6-24V Plug / Socket | 3 Pin 6-24V Fiş / Soket

Socket Soket	Order Number Sipariş Kodu	Plug Fiş
E4703	 200 pcs Adet	E4706



Single Pole Power Plug (High Amper)
Tek Kutuplu Güç Fişi (Yüksek Amper için)

Order Number | Sipariş Kodu

E0449F



Single Pole Power Plug
Tek Kutuplu Güç Fişi

Order Number | Sipariş Kodu

E0447F



Single Pole Power Plug (With Cap)
Tek Kutuplu Güç Fişi (Kapaklı)

Order Number | Sipariş Kodu

E0448F

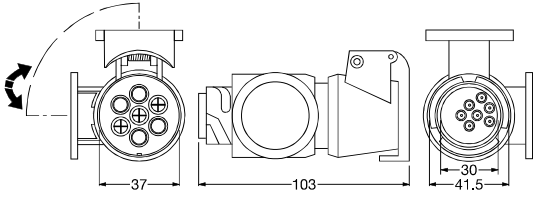

ISO 11446
ISO 1724

12V Short Adapter Socket 7 Poles
12V Kısa Adaptör Soket 7 Kutup

Order Number | Sipariş Kodu
Socket | Soket



E2311

100 pcs Adet

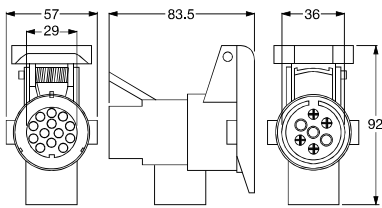

ISO 11446
ISO 1724

12V Short Adapter Socket 7-13 Poles
12V Kısa Adaptör Soket 7-13 Kutup

Order Number | Sipariş Kodu
Socket | Soket



E2312

100 pcs Adet

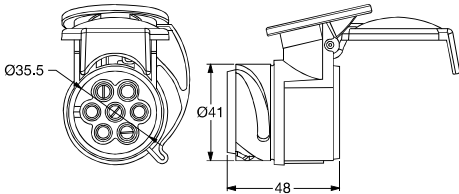

ISO 11446
ISO 1724

12V Short Adapter Socket 7 Poles
12V Kısa Adaptör Soket 7 Kutup

Order Number | Sipariş Kodu
Socket | Soket



E2315

100 pcs Adet

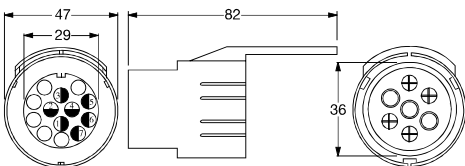

ISO 11446
ISO 1724

12V Short Adapter Socket 7 Poles
12V Kısa Adaptör Soket 7 Kutup

Order Number | Sipariş Kodu
Socket | Soket



E2321

100 pcs Adet











Heavy Duty Spiral Twin Cable 24V | Ağır İş Spiral İkiz Kablo 24V

according to
VG 96917 ✓

Straith Cables | Düz Kablolar

Insulation: TPU
Operating Temperature : -40°C + 80°C

	2 Plugs, 2 Pins with Plug		Without Plug	
Cable with Connectors Bağlantısız Yalnız Kablo	E4220F40 E4230F40	E4220F60 E4230F60	E4320F40 E4330F40	E4320F60 E4330F60
Voltage Compatability Voltaj Uyumluluğu	35 50	35 50	35 50	35 50
Turns / Internal Diameter Sarımlar Sayısı / İç Çap mm	52/40 mm	84/40 mm	52/40 mm	84/40 mm
Cable Length (m)/Working Length (m) Kablo Uzunluğu (m)/Çalışma Uzunluğu (m)	5,4 / 4	8,1 / 6	5,4 / 4	8,1 / 6
 5 pcs Adet				

Cooper Section (mm ²)	Colour	Order Number
16		QKL1600SYH-STŞ
		QKL1600KRM-STŞ
25		QKL2500SYH-STŞ
		QKL2500KRM-STŞ
35		QKL3500SYH-STŞ
		QKL3500KRM-STŞ
50		QKL5000SYH-STŞ
		QKL5000KRM-STŞ
70		QKL7000SYH-STŞ
		QKL7000KRM-STŞ

Heavy Duty Aluminium Socket with Silver Plated Crimp Contact (x2) for Cables
Ağır İş Alüminyum Soket-Gümüş Kaplı Kontak (x2) Kablolar için



according to
VG 96917 ✓



Plastic Grommet



Order Number | Sipariş Kodu

Contact Section 35mm ²	Contact Section 50mm ²	Plastic Grommet
E4702	E4710	E4708
50 pcs Adet		100 pcs Adet

Heavy Duty Plug with Silver Plated Crimp Contact (x2) for Cables
Ağır İş Alüminyum Fiş-Gümüş Kaplı Kontak (x2) Kablolar için



according to
VG 96917 ✓



Order Number | Sipariş Kodu

Metal Body Contact Section 35mm ²	Contact Section 50mm ²	With Rubberized Body Contact Section 35mm ²
E4002	4711	E4004
50 pcs Adet		

Heavy Duty Aluminium Plug with Silver Plated Crimp Contact (x2) for Cables
Ağır İş Alüminyum Fiş-Gümüş Kaplı Kontak (x2) Kablolar için



according to
VG 96917 ✓



Order Number | Sipariş Kodu

Contact Section 35mm ²	Contact Section 50mm ²
E2328	E2329
50 pcs Adet	

according to
ISO7375 ✓ **ISO7628** ✓
 TEST REPORT AVAILABLE

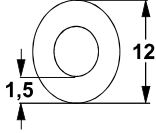
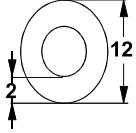

Hose thickness
 Hortum Kalınlığı



POLYAMİDE 12 POLİAMİT 12 DIN 74324	Turns Spir	Colors Renk	Anti Kint Protection Kol Koruması	Thread Rakor	Inner Ø 70 mm İç Çap 70 mm	Inner Ø 90 mm İç Çap 90 mm
	19	●	Plastic Plastik	M16	F3820H19S16	F3820HV19S16
	19	●	Plastic Plastik	M16	F3820H19K16	F3820HV19K16
	19	●	Plastic Plastik	M22	F3820H19S22	F3820HV19S22
	19	●	Plastic Plastik	M22	F3820H19K22	F3820HV19K22
	22	●	Plastic Plastik	M16	F3820H22K16	F3820HV22K16
	22	●	Plastic Plastik	M16	F3820H22S16	F3820HV22S16
	22	●	Plastic Plastik	M22	F3820H22S22	F3820HV22S22
	22	●	Plastic Plastik	M22	F3820H22K22	F3820HV22K22
	30	●	Plastic Plastik	M16	F3820H30S16	F3820HV30S16
	30	●	Plastic Plastik	M16	F3820H30K16	F3820HV30K16
	30	●	Plastic Plastik	M22	F3820H30S22	F3820HV30S22
	30	●	Plastic Plastik	M22	F3820H30K22	F3820HV30K22
	19	●	Plastic Plastik	M16	F3820H19Z16	F3820HV19Z16
	22	●	Plastic Plastik	M16	F3820H22Z16	F3820HV22Z16
	30	●	Plastic Plastik	M16	F3820H30Z16	F3820HV30Z16
	19	●	Plastic Plastik	M22	F3820H19Z22	F3820HV19Z22
	22	●	Plastic Plastik	M22	F3820H22Z22	F3820HV22Z22
	30	●	Plastic Plastik	M22	F3820H30Z22	F3820HV30Z22

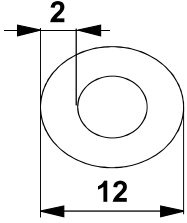

Inner Ø 50 mm
İç Çap 50 mm

Hose thickness
Hortum Kalınlığı



POLYURETHANE (TPU) POLİÜRETAN (TPU)	Turns	Colors	Tip guard	Thread	Metal Conn.	Brass Conn.
	Spir	Renk	Uç Koruması	Rakor	Metal Konnektör	Pirinç Konnektör
	22	●	Spring Yay	M22	F3128HKW22MT	F3128HKW22PR
	22	●	Spring Yay	M16	F3128HKW16MT	F3128HKW16PR
	22	●	Spring Yay	M22	F3128HSW22MT	F3128HSW22PR
	22	●	Spring Yay	M16	F3128HSW16MT	F3128HSW16PR
	22	●	Red Plastic Kırmızı Plastik	M22	F3128HZK22MT	F3128HZK22PR
	22	●	Red Plastic Kırmızı Plastik	M16	F3128HZK16MT	F3128HZK16PR
	22	●	Yellow Plastic Sarı Plastik	M22	F3128HZZ16MT	F3128HZZ16PR
	22	●	Yellow Plastic Sarı Plastik	M16	F3128HZZ16MT	F3128HZZ16PR
	22	●	Blue Plastic Mavi Plastik	M22	F3128HZZ22MT	F3128HZZ22PR
	22	●	Blue Plastic Mavi Plastik	M16	F3128HZZ16MT	F3128HZZ16PR
22	●	Spring Yay	M16	F3128HZZ16MT	F3128HZZ16PR	

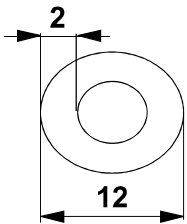

Big Hose Inner Diameter 70 mm
Büyük Hortum İç Çapı 70 mm

Small Hose Inner Diameter 55 mm
Küçük Hortum İç Çapı 55 mm

Hose thickness
Hortum Kalınlığı



POLYURETHANE (TPU) POLİÜRETAN (TPU)	Turns	Colors	Tip guard	Thread	Metal Conn.	Brass Conn.
	22	● / ●	Spring Yay	M22	F3129HSKW22MT	F3129HSKW22PR
	22	● / ●	Spring Yay	M16	F3129HSKW16MT	F3129HSKW16PR
	22	● / ●	Spring Yay	M22	F3129HZZ22MT	F3129HZZ22PR
	22	● / ●	Spring Yay	M16	F3129HZZ16MT	F3129HZZ16PR
	22	● / ●	Red/Yellow Plastic Kırmızı/Sarı Plastik	M22	F3129HSKSK22MT	F3129HSKSK22PR
	22	● / ●	Red/Yellow Plastic Kırmızı/Sarı Plastik	M16	F3129HSKSK16MT	F3129HSKSK16PR
	22	● / ●	Black/Yellow Plastic Siyah/Sarı Plastik	M22	F3129HZZSZS22MT	F3129HZZSZS22PR
	22	● / ●	Black/Yellow Plastic Siyah/Sarı Plastik	M16	F3129HZZSZS16MT	F3129HZZSZS16PR



Palm-Couplings for Two Line System
with Integrated Filter
Withworth 1/2 inches also available

M 16 x 1,5

For emergency Red **F3825KK16**

For brake Yellow **F3825KS16**



Palm-Couplings for Two Line System
Confusion Preventing Type
Automatic Type (with valve)
Withworth 1/2 inches also available

M 16 x 1,5 M 22 x 1,5

For emergency Red **F3822KK16 F3822KK22**

For brake Yellow **F3822KS16 F3822KS22**



Palm-Couplings for Two Line System
Confusion Preventing Type
Standart Type (w/o valve)

M 16 x 1,5 M 22 x 1,5

For emergency Red **F3823KK16 F3823KK22**

For brake Yellow **F3823KS16 F3823KS22**



Coupling Head Handle Kit

M 16 x 1,5

M 22 x 1,5

E2938M16

E2938M22



Aluminium Coupling
Head Handle (One piece)

M 16 x 1,5

M 22 x 1,5

E2939M16

E2939M22



Drain Valve

M 16 x 1,5

M 22 x 1,5

F3824H16

F3824H22



*Inner diameter 45mm

Plastic Gun
Order No: **F2935-Z**
Different Colours
also available



Metal Gun
Order No: **F2933H**



Order Number | Sipariş Kodu

Turns	Colors	Working Length	Metal/Plastic Gun	CONNECTION TYPE			
				Without Gun	With Gun	Without Gun	With Gun
48	●	7,5m	Metal	F2930HB	F2931HB	F2936HB	F2937HB
48	●	7,5m	Metal	F2930HK	F2931HK	F2936HK	F2937HK
48	●	7,5m	Plastic	F2930HK	F2931HKP	F2936HK	F2937HKP
48	●	7,5m	Metal	F2930HM	F2931HM	F2936HM	F2937HM
48	●	7,5m	Plastic	F2930HM	F2931HMP	F2936HM	F2937HMP
48	●	7,5m	Metal	F2930HS	F2931HS	F2936HS	F2937HS
48	●	7,5m	Plastic	F2930HS	F2931HSP	F2936HS	F2937HSP
48	●	7,5m	Metal	F2930HT	F2931HT	F2936HT	F2937HT
48	●	7,5m	Metal	F2930HY	F2931HY	F2936HY	F2937HY
35	●	5,5m	Metal	F2930HK55	F2932HK	F2936HK55	F2938HK
35	●	5,5m	Plastic	F2930HM55	F2932HMP	F2936HM55	F2938HMP
35	●	5,5m	Metal	F2930HS55	F2932HS	F2936HS55	F2938HS
35	●	5,5m	Plastic	F2930HK55	F2932HKP	F2936HK55	F2938HKP

Considering your demands, different connection, turns, dimensions and colours could be produced.

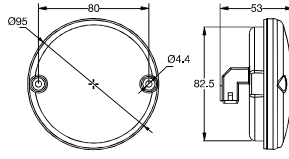

Bus Tail Indicator Lamp (12 LEDs)
Otobüs Arka Sinyal Lambası (12 Ledli)

Order Number | Sipariş Kodu Connector Set

0391LUS-K

QSK55-ST5

E9 LED EMC IP69K

12/24V



45 pcs Adet

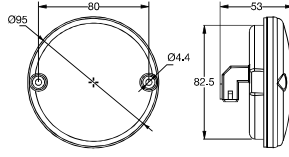

Bus Tail Stop-Position Lamp (12 LEDs)
Otobüs Arka Stop ve Pozisyon Lambası (12 Ledli)

Order Number | Sipariş Kodu Connector Set

0392LUK-K

QSK56-ST5

E9 LED EMC IP69K

12/24V



45 pcs Adet

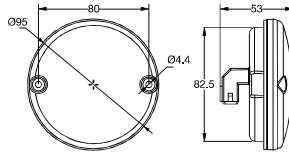

Bus Reverse Lamp (12 LEDs)
Otobüs Geri Vites Lambası (12 Ledli)

Order Number | Sipariş Kodu Connector Set

0394LUB-K

QSK55-ST5

E9 LED EMC IP69K

12/24V



45 pcs Adet

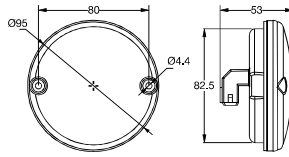

Bus Tail Fog Lamp (12 LEDs)
Otobüs Arka Sis Lambası (12 Ledli)

Order Number | Sipariş Kodu Connector Set

0395LUK-K

QSK55-ST5

E9 LED EMC IP69K

12/24V



45 pcs Adet

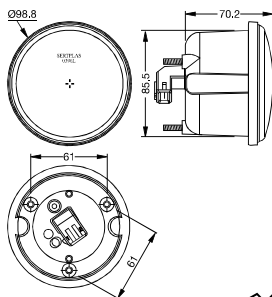

Bus Tail Fog Lamp (12 LEDs)
Otobüs Arka Sis Lambası (12 Ledli)

Order Number | Sipariş Kodu Connector Set

0396LUK-K

QSK55-ST5

E9 LED EMC IP69K

12/24V



56 pcs Adet

Bus Tail Indicator Lamp with Cable (12 LEDs)
Kablolu Otobüs Arka Sinyal Lambası (12 Ledli)

Order Number Sipariş Kodu		
With Cable Kablolu	Assembly Base Montaj Plastikli	Connector Base Bağlantı Plastikli
0391LUS25	0391LUS25-M	0391LUS25-B
45 pcs Adet		

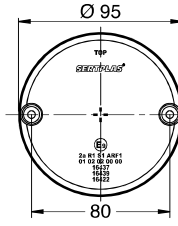
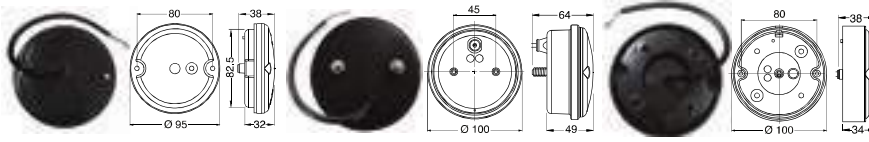

Cable Length | Kablo Uzunluğu: 25 cm

12/24V



Bus Tail Stop-Position Lamp with Cable (12 LEDs)
Kablolu Otobüs Stop ve Pozisyon Lambası (12 Ledli)

Order Number Sipariş Kodu		
With Cable Kablolu	Assembly Base Montaj Plastikli	Connector Base Bağlantı Plastikli
0392LUK25	0392LUK25-M	0392LUK25-B
45 pcs Adet		

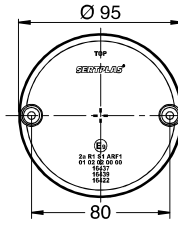
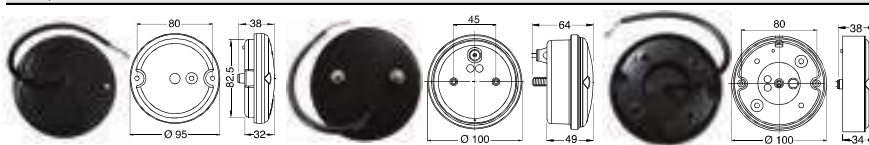

Cable Length | Kablo Uzunluğu: 25 cm

12/24V



Bus Reverse Lamp with Cable (12 LEDs)
Kablolu Otobüs Geri Vites Lambası (12 Ledli)

Order Number Sipariş Kodu		
With Cable Kablolu	Assembly Base Montaj Plastikli	Connector Base Bağlantı Plastikli
0394LUB25	0394LUB25-M	0394LUB25-B
45 pcs Adet		

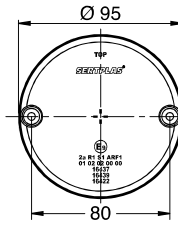
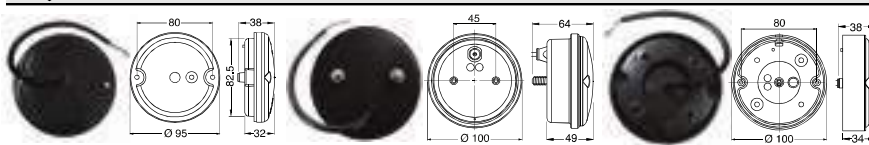

Cable Length | Kablo Uzunluğu: 25 cm

12/24V



Bus Fog Lamp with Cable (12 LEDs)
Kablolu Otobüs Arka Sis Lambası (12 Ledli)

Order Number Sipariş Kodu		
With Cable Kablolu	Assembly Base Montaj Plastikli	Connector Base Bağlantı Plastikli
0395LUK25	0395LUK25-M	0395LUK25-B
45 pcs Adet		

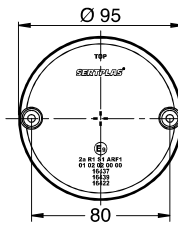
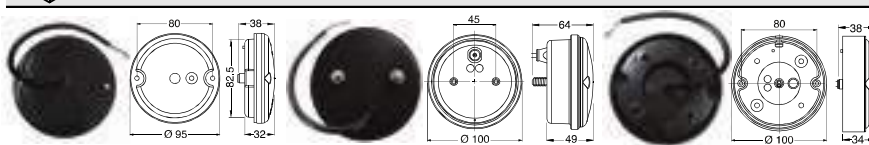

Cable Length | Kablo Uzunluğu: 25 cm

12/24V



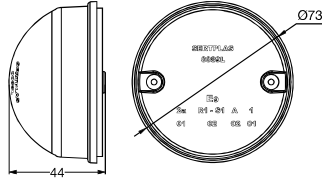

Indicator Lamp with Cable (8 LEDs)
Kablolu Sinyal Lambası (8 Ledli)
 The Lamp without Plug is available

Order Number
Sipariş Kodu

0089LUS



12/24V



45 pcs Adet

Cable Length
Kablo Uzunluğu
 15 cm

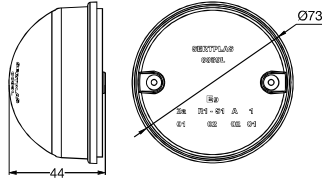

Stop / Position Lamp with Cable (8 LEDs)
Kablolu Stop / Pozisyon Lambası (8 Ledli)
 The Lamp without Plug is available

Order Number
Sipariş Kodu

0089LUK



12/24V



45 pcs Adet

Cable Length
Kablo Uzunluğu
 15 cm

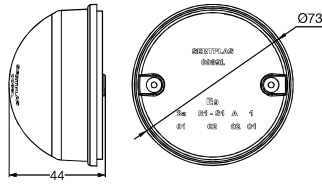

Front Position Lamp with Cable (8 LEDs)
Kablolu Ön Pozisyon Lambası (8 Ledli)
 The Lamp without Plug is available

Order Number
Sipariş Kodu

0089LUB



12/24V



45 pcs Adet

Cable Length
Kablo Uzunluğu
 15 cm

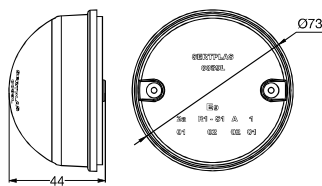

Front Direction Indicator Lamp with Cable (8 LEDs)
Kablolu Ön Sinyal Lambası (8 Ledli)
 The Lamp without Plug is available

Order Number
Sipariş Kodu

0089LUSB



12/24V



45 pcs Adet

Cable Length
Kablo Uzunluğu
 15 cm

Off-Road Vehicle LED Lighting Set (includes 12 spare parts)
 Compatible with Land Rover
 Off-Road Araç Aydınlatma Seti (12 Parça)
 Land Rover ile Uyumlu

Order Number
 Sipariş Kodu

S0089L2

Set Content | Set İçeriği

PART NUMBER	DESCRIPTION	PCS
0089LUS	• Direction Indicator Lamp	2
0089LUB	• Front Position Lamp	2
0089LUK	• Stop&Position Lamp	2
0089LUSB	• Front Direction Indicator Lamp	2
0394LUB25-B	• Reversing Lamp	1
0395LUK25-B	• Fog Lamp	1
0092LUB	• Number Plate Lamp	1
ÜKM187	• LED Flasher Unit	1



12-24V



Off-Road Vehicle LED Lighting Set (includes 9 spare parts)
 Compatible with Land Rover
 Off-Road Araç Aydınlatma Seti (9 Parça)
 Land Rover ile Uyumlu

Order Number
 Sipariş Kodu

S0089L1

Set Content | Set İçeriği

PART NUMBER	DESCRIPTION	PCS
0089LUS	• Direction Indicator Lamp	2
0089LUB	• Front Position Lamp	2
0089LUK	• Stop&Position Lamp	2
0089LUSB	• Front Direction Indicator Lamp	2
ÜKM187	• LED Flasher Unit	1



12-24V

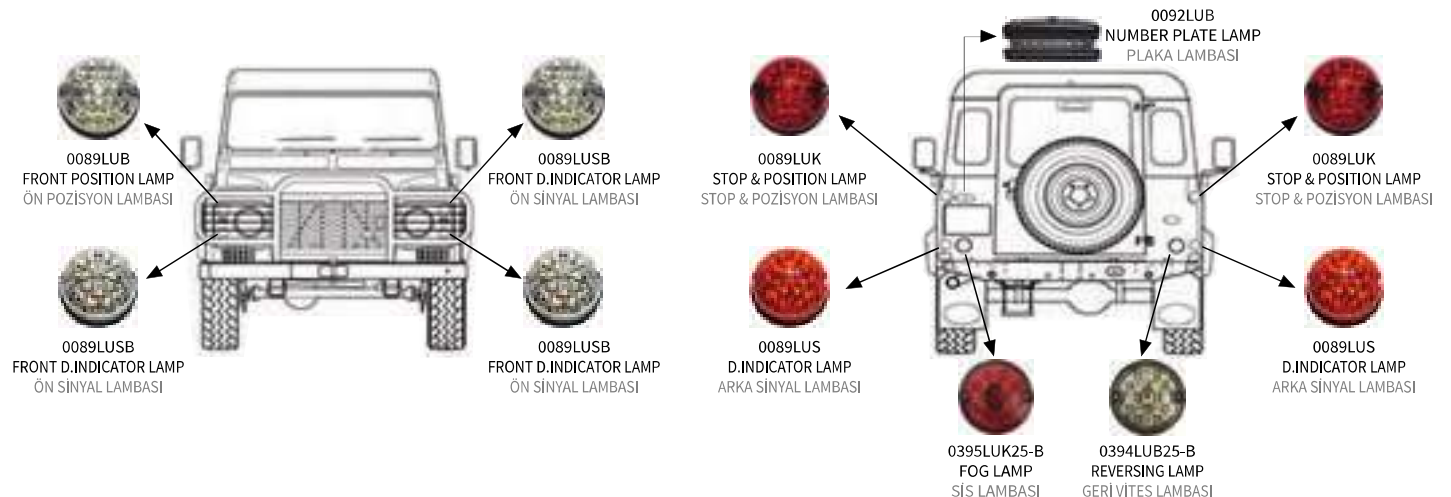



24V

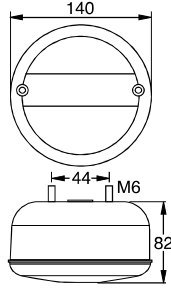

Hamburger Type Rear Lamp with LED
Hamburger Tip LEDli Arka Lamba

Order Number | Sipariş Kodu

0230LLED

40 pcs Adet



24V

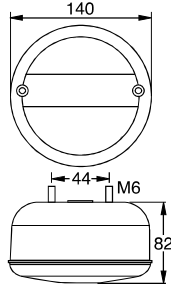

Hamburger Type Fog & Reverse Lamp with LED
Hamburger Tip LEDli Sis&Geri Vites Lambası

Order Number | Sipariş Kodu

0375LLED

40 pcs Adet



24V

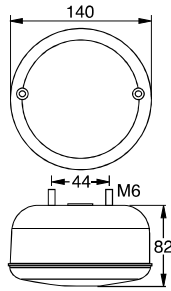

Hamburger Type Fog Lamp with LED
Hamburger Tip LEDli Sis Lambası

Order Number | Sipariş Kodu

0361LLED

40 pcs Adet



24V

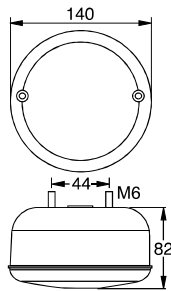

Hamburger Type Reverse Lamp with LED
Hamburger Tip LEDli Geri Vites Lambası

Order Number | Sipariş Kodu

0363LLED

40 pcs Adet



24V

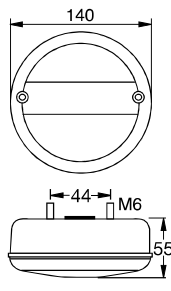

Hamburger Type Rear Lamp with LED
Hamburger Tip LEDli Arka Lambası

Order Number | Sipariş Kodu

0380L

40 pcs Adet

Cable Length
Kablo Uzunluğu
90 cm

Multifunction Tail Lamp

0366

LED'li Çok Fonksiyonlu Kuyruk Lambası

Functions Stop, Side Marker, Position, Reflector, Rear Fog, Indicator, Front Position, Reverse, Num. Plate

Fonksiyonlar Stop, Yan Marker, Pozisyon, Reflektör, Arka Sis, Sinyal, Ön Pozisyon, Geri Vites, Plaka Lambası

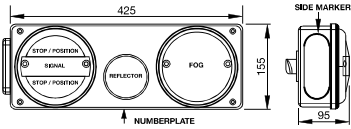

Without LED Marker
LED Boynuzsuz

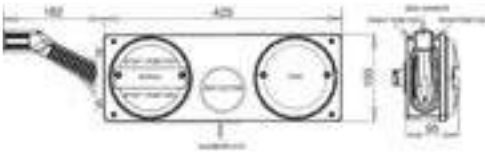

With LED Marker
LED Boynuzlu

A Light Control Gear kit is integrated to product against to Indicator Failures. This Light Control Gear (LCG) enables truck&trailers with a non LED conform electrical system to operate LED lamps by adjust the electrical properties.

Order Number | Sipariş Kodu



Left
Sol

0366LL73Q2



Right
Sağ

0366LR73Q2



Left
Sol

0366LL73Q25



Right
Sağ

0366LR73Q25



14 pcs Adet



20 pcs Adet

Fastening Bolts | Bağlantı Civataları

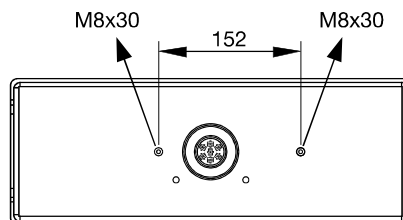

0302

Multifunction Tail Lamp
Çok Fonksiyonlu Kuyruk Lambası



Functions Reverse, End Outline Marker, Stop, Side Marker, Position, Reflector, Rear Fog, Indicator, Num. Plate
Fonksiyonlar Geri Vites, Uç Yan Marker, Stop, Yan Marker, Pozisyon, Reflektör, Sinyal, Arka Sis, Plaka

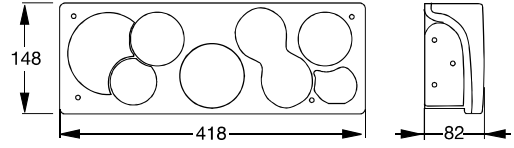

Order Number | Sipariş Kodu



Left
Sol

Right
Sağ

0302LL73Q2

0302LR73Q2



13 pcs Adet

Lens Code | Cam Kodu



0302CL

0302CR



16 pcs Adet

Fastening Bolts | Bağlantı Civataları

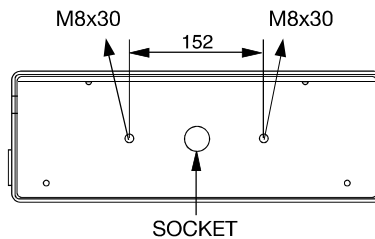

Multifunction Tail Lamp

0030

Çok Fonksiyonlu Kuyruk Lambası





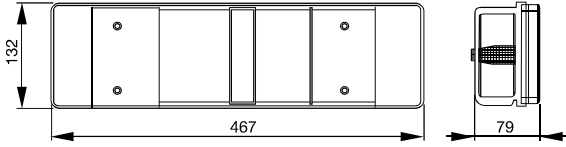



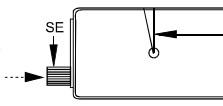

Functions Reverse, End-Outline Marker, Stop, Side Marker, Position, Reflector, Rear Fog, Indicator, Num. Plate

Fonksiyonlar Geri Vites, Uç Yan Marker, Stop, Yan Marker, Pozisyon, Reflektör, Sinyal, Arka Sis, Plaka

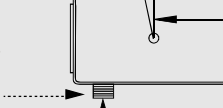

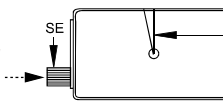
Order Number | Sipariş Kodu

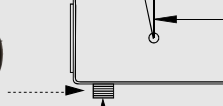

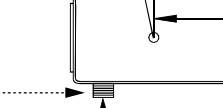
Left Sol	Socket Type Bağlantı Tipi	Right Sağ	
0030LL744 SE Type AMP			0030LR744 14 pcs Adet
0030LL741 US Type AMP			0030LR741 14 pcs Adet
0030LL742 SE Type AMP			0030LR742 14 pcs Adet
0030LL501 US Universal Socket			0030LR501 14 pcs Adet
0030LL511 US Universal Socket and Cable (60 cm)			0030LR511 14 pcs Adet

Lens Code | Cam Kodu



0030CU



30 pcs Adet

Fastening Bolts | Bağlantı Civataları

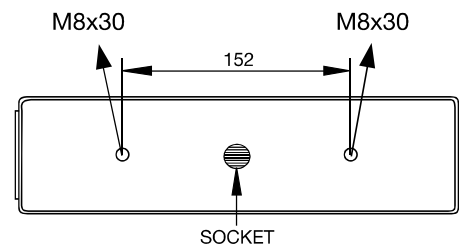

0030

Multifunction Tail Lamp
Çok Fonksiyonlu Kuyruk Lambası







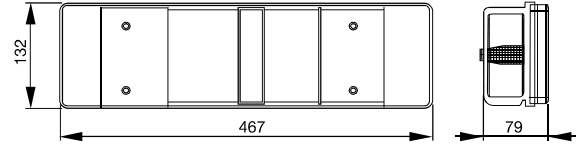

Functions Reverse, End-Outline Marker, Stop, Side Marker, Position, Reflector, Rear Fog, Indicator, Num. Plate

Fonksiyonlar Geri Vites, Uç Yan Marker, Stop, Yan Marker, Pozisyon, Reflektör, Sinyal, Arka Sis, Plaka

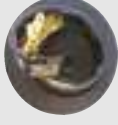
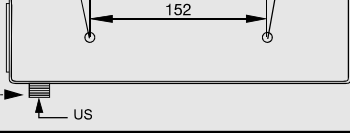

Order Number | Sipariş Kodu

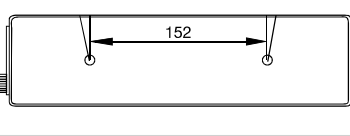
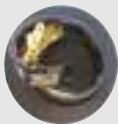

Left Sol	Socket Type Bağlantı Tipi	Right Sağ	
0030LL601 US Gromet Type	 	0030LR601 14 pcs Adet	
0030LL611 US Gromet and Cable (30 cm)	 	0030LR611 14 pcs Adet	
0030LL602 SE Gromet Type	 	0030LR602 14 pcs Adet	
0030LL612 SE Gromet and Cable (30 cm)	 	0030LR612 14 pcs Adet	

Lens Code | Cam Kodu



0030CU



30 pcs Adet

Fastening Bolts | Bağlantı Civataları

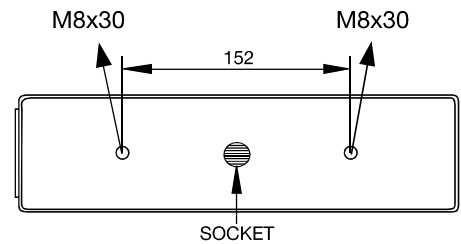

Multifunction Tail Lamp

0030

Çok Fonksiyonlu Kuyruk Lambası

Functions Reverse, End-Outline Marker, Stop, Side Marker, Position, Reflector, Rear Fog, Indicator, Num. Plate

Fonksiyonlar Geri Vites, Uç Yan Marker, Stop, Yan Marker, Pozisyon, Reflektör, Sinyal, Arka Sis, Plaka

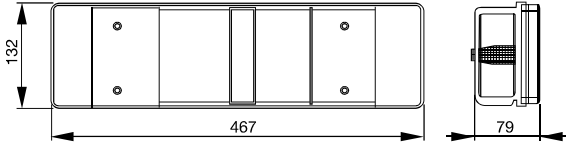

Order Number | Sipariş Kodu



Left Sol	Socket Type Bağlantı Tipi	Right Sağ	
0030LL71	Iveco Socket Type	0030LR71	14 pcs Adet
0030LL72	Schlemmer Socket Type	0030LR72	14 pcs Adet
0030LL73	Austrian Blade Socket Type	0030LR73	14 pcs Adet
0030LL74	AMP Socket Type	0030LR74	14 pcs Adet
0030LL75	DAF Socket Type	0030LR75	14 pcs Adet

Lens Code | Cam Kodu

Fastening Bolts | Bağlantı Civataları



0030CU

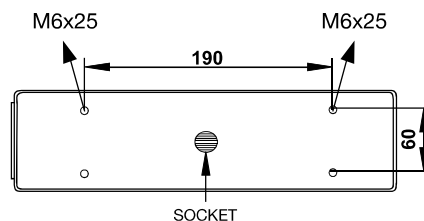
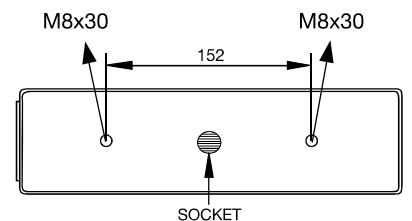

30 pcs Adet

For 0030LL71
(Iveco Type)

0030

Multifunction Tail Lamp
Çok Fonksiyonlu Kuyruk Lambası



Functions Reverse, End-Outline Marker, Stop, Side Marker, Position, Reflector, Rear Fog, Indicator, Num. Plate

Fonksiyonlar Geri Vites, Uç Yan Marker, Stop, Yan Marker, Pozisyon, Reflektör, Sinyal, Arka Sis, Plaka

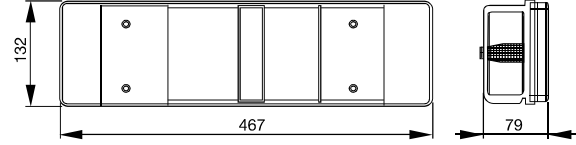

Order Number | Sipariş Kodu



Left Sol	Socket Type Bağlantı Tipi	Right Sağ	
0030LL50 Universal Gromet		0030LR50 14 pcs Adet	
0030LL51 Universal Socket with Cable (60 cm)		0030LR51 14 pcs Adet	
0030LL60 With Gromet Socket		0030LR60 14 pcs Adet	
0030LL61 With Gromet Socket and Cable (30 cm)		0030LR61 14 pcs Adet	

Lens Code | Cam Kodu



0030CU



30 pcs Adet

Fastening Bolts | Bağlantı Civataları

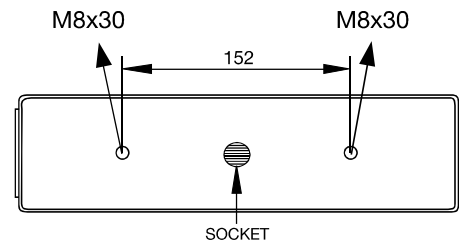

Multifunction Tail Lamp

0031

Çok Fonksiyonlu Kuyruk Lambası

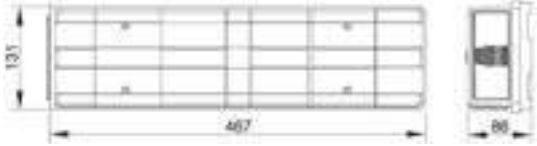

Functions Reverse, End-Outline Marker, Stop, Side Marker, Position, Reflector, Rear Fog, Indicator, Num. Plate

Fonksiyonlar Geri Vites, Uç Yan Marker, Stop, Yan Marker, Pozisyon, Reflektör, Sinyal, Arka Sis, Plaka



Order Number | Sipariş Kodu

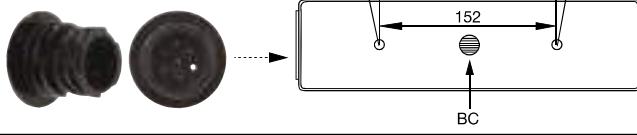

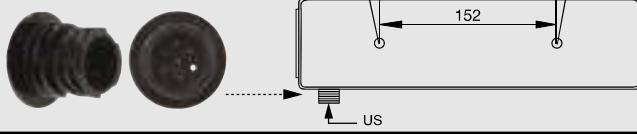
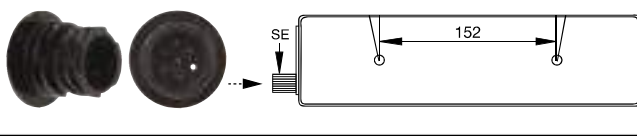
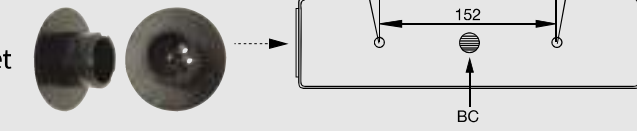
Left Sol	Socket Type Bağlantı Tipi	Right Sağ	
0031LL74 BC Type AMP		0031LR74 14 pcs Adet	
0031LL741 US Type AMP		0031LR741 14 pcs Adet	
0031LL742 SE Type AMP		0031LR742 14 pcs Adet	
0031LL72 Schlemmer Socket		0031LR72 14 pcs Adet	

Lens Code | Cam Kodu



0031CU

Fastening Bolts | Bağlantı Civataları

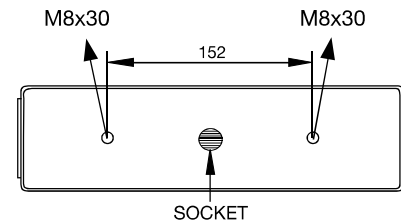

20 pcs Adet

0031

Multifunction Tail Lamp
Çok Fonksiyonlu Kuyruk Lambası



Functions Reverse, End-Outline Marker, Stop, Side Marker, Position, Reflector, Rear Fog, Indicator, Num. Plate

Fonksiyonlar Geri Vites, Uç Yan Marker, Stop, Yan Marker, Pozisyon, Reflektör, Sinyal, Arka Sis, Plaka



Order Number | Sipariş Kodu



Left Sol	Socket Type Bağlantı Tipi	Right Sağ	
0031LL50 Universal Gromet		0031LR50 14 pcs Adet	
0031LL51 Universal Gromet with Cable (60 cm)		0031LR51 14 pcs Adet	
0031LL60 With Gromet		0031LR60 14 pcs Adet	
0031LL61 With Gromet and Cable (30 cm)		0031LR61 14 pcs Adet	
0031LL73 Austrian Blade Socket		0031LR73 14 pcs Adet	

Lens Code | Cam Kodu



0031CU



20 pcs Adet

Fastening Bolts | Bağlantı Civataları

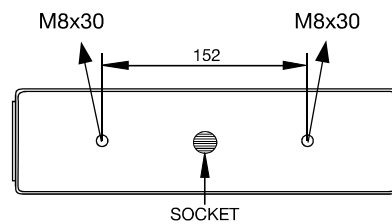

Multifunction Tail Lamp

0284

Çok Fonksiyonlu Kuyruk Lambası

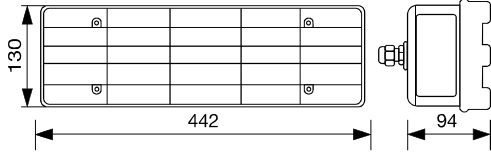
Functions Stop, Side Marker, Position, Rear Fog, Indicator, Reverse**Fonksiyonlar** Stop, Yan Marker, Pozisyon, Arka Sis, Sinyal, Geri Vites

Order Number Sipariş Kodu	Socket Type Bağlantı Tipi	
0284LU51 Universal Gromet with Cable (60 cm)		14 pcs Adet
0284LU60 With Gromet		14 pcs Adet
0284LU61 With Gromet & Cable (30 cm)		14 pcs Adet
0284LU78 Iveco Socket Type		14 pcs Adet
0284LU79 With Socket and Cable (190 cm)		14 pcs Adet

Lens Code | Cam Kodu

**0284CU**

20 pcs Adet

Fastening Bolts | Bağlantı Civataları

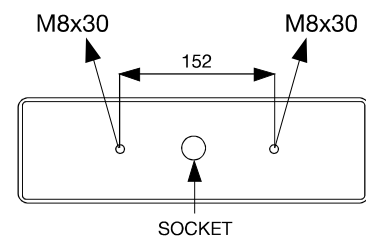

0195

Multifunction Tail Lamp

Çok Fonksiyonlu Kuyruk Lambası



Functions Stop, Position, Indicator, Reverse, Rear Fog, Reflector

Fonksiyonlar Stop, Pozisyon, Sinyal, Geri Vites, Arka Sis, Reflektör

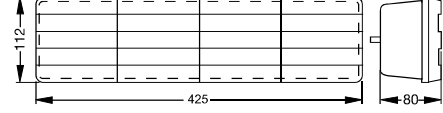

Order Number | Sipariş Kodu



Left
Sol

Right
Sağ

0195LLSK60**0195LR SB60**

13 pcs Adet

Lens Code | Cam Kodu

**0195CUSK****0195CUSB**

30 pcs Adet

Fastening Bolts | Bağlantı Civataları

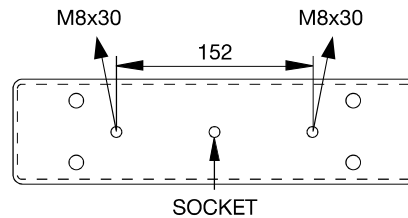

Multifunction Tail Lamp

Çok Fonksiyonlu Kuyruk Lambası

0205

Functions Reverse, Stop, Position, Reflector, Indicator, Rear Fog, Num. Plate

Fonksiyonlar Geri Vites, Stop, Pozisyon, Reflektör, Sinyal, Arka Sis, Plaka

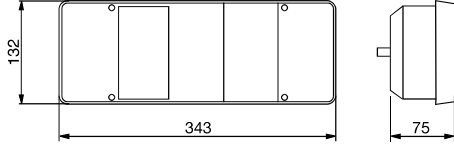

Order Number | Sipariş Kodu



Left Sol	Socket Type Bağlantı Tipi	Right Sağ	
0205LL51	Universal Gromet and Cable (60 cm)	0205LR51	15 pcs Adet
0205LL60	With Gromet	0205LR60	15 pcs Adet
0205LL72	Schlemmer Socket Type	0205LR72	15 pcs Adet
0205LL74	AMP Socket Type	0205LR74	15 pcs Adet

Lens Code | Cam Kodu



0205CU



30 pcs Adet

Fastening Bolts | Bağlantı Civataları

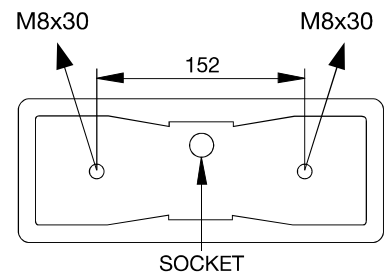

0294

Multifunction Tail Lamp
Çok Fonksiyonlu Kuyruk Lambası

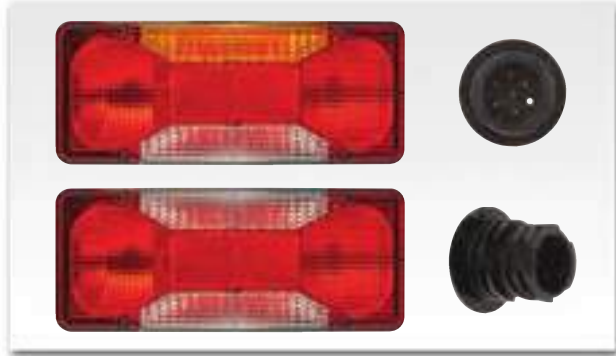

Functions Stop, Position, Indicator, Reverse, Rear Fog, Reflector

Fonksiyonlar Stop, Pozisyon, Sinyal, Geri Vites, Arka Sis, Reflektör

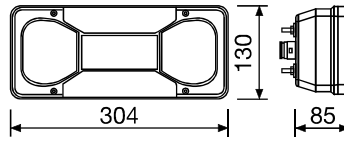

Fastening Bolts | Bağlantı Civataları

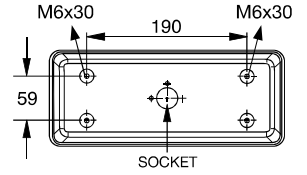

Order Number | Sipariş Kodu



Left
Sol

Right
Sağ

Left
Sol

Right
Sağ

0294LL74SB

0294LR74SB

0294LL74BB

0294LR74BB



15 pcs Adet



15 pcs Adet

Lens Code | Cam Kodu



0294CLSB

0294CRSB

0294CUB



40 pcs Adet



40 pcs Adet

Multifunction Tail Lamp

Çok Fonksiyonlu Kuyruk Lambası

0153

Functions Reverse, Stop, Position, Reflector, Indicator**Fonksiyonlar** Geri Vites, Stop, Pozisyon, Reflektör, Sinyal

Fastening Bolts | Bağlantı Civataları

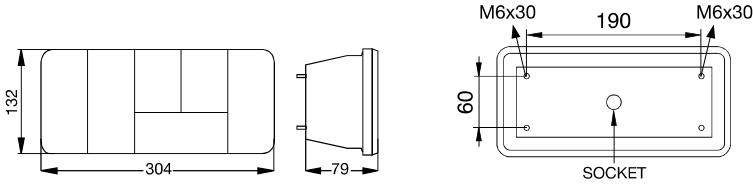

Order Number | Sipariş Kodu

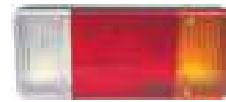
Left
SolSocket Type
Bağlantı TipiRight
Sağ**0153LLSK71** Iveco Socket Type**0153LRSB71**

15 pcs Adet

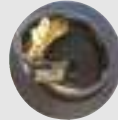
0153LLSK61 With Gromet and Cable (30 cm)**0153LRSB61**

15 pcs Adet

0153LLSK74 AMP Socket Type**0153LRSB74**

15 pcs Adet

Lens Code | Cam Kodu

**0153CLSK****0153CRSB**

40 pcs Adet

0029

Multifunction Tail Lamp
Çok Fonksiyonlu Kuyruk Lambası**Functions** Reverse, Stop, Position, Rear Fog, Indicator, Num. Plate**Fonksiyonlar** Geri Vites, Stop, Pozisyon, Arka Sis, Sinyal, Plaka

Fastening Bolts | Bağlantı Civataları

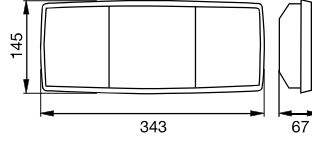
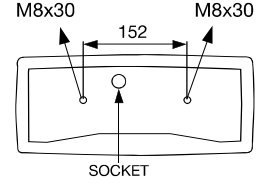

Order Number | Sipariş Kodu

Left
Sol

0029LLSK60

Right
Sağ

0029LRSB60



18 pcs Adet

Lens Code | Cam Kodu



0029CUSK



0029CUSB



30 pcs Adet

Multifunction Tail Lamp

0221

Çok Fonksiyonlu Kuyruk Lambası

Functions Reverse, Stop, Position, Reflector, Rear Fog, Indicator, Num. Plate

Fonksiyonlar Geri Vites, Stop, Pozisyon, Reflektör, Arka Sis, Sinyal, Plaka

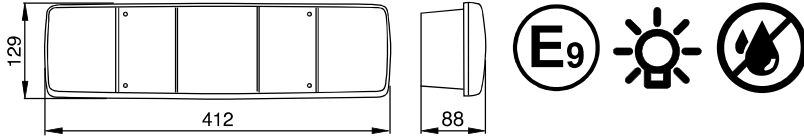

Order Number | Sipariş Kodu



Left Sol	Socket Type Bağlantı Tipi	Right Sağ	
0221LL60 With Gromet		0221LR60	13 pcs Adet
0221LL61 With Gromet & Cable (30 cm)		0221LR61	13 pcs Adet

Lens Code | Cam Kodu

**0221CUSB**

30 pcs Adet

Fastening Bolts | Bağlantı Civataları

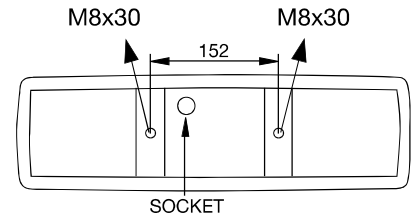
Hamburger Type Rear Lamp
Hamburger Tip Arka Lamba

Order Number | Sipariş Kodu

Left | Sol

Right | Sağ

0021LL**0021LR**

40 pcs Adet



*Left lamp includes numberplate functions.

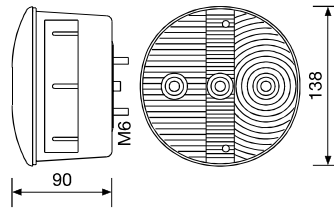

Caravan Lamp | Karavan Lambası

Order Number | Sipariş Kodu

Left | Sol

Right | Sağ

0076LLSK60**0076LR SK60**

18 pcs Adet



*Right lamp includes numberplate functions.

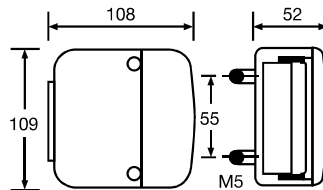

0182

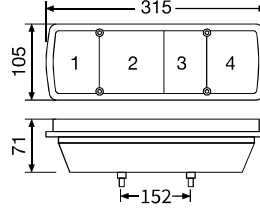
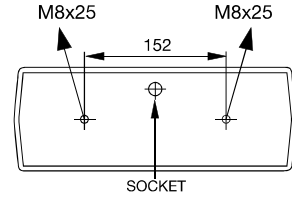
Multifunction Tail Lamp
Çok Fonksiyonlu Kuyruk Lambası**Functions** Reverse, Stop, Position, Indicator**Fonksiyonlar** Geri Vites, Stop, Pozisyon, Sinyal**Fastening Bolts** | Bağlantı Civataları

Order Number | Sipariş Kodu



15 pcs Adet

0182LU60

Lens Code | Cam Kodu



15 pcs Adet

0182CU

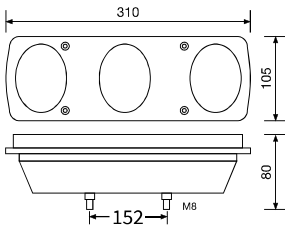
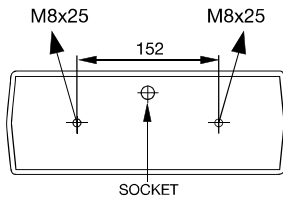
Functions Reverse, Stop, Position, Indicator**Fonksiyonlar** Geri Vites, Stop, Pozisyon, Sinyal**Fastening Bolts** | Bağlantı Civataları

Order Number | Sipariş Kodu



15 pcs Adet

0214LU60

Lens Code | Cam Kodu



15 pcs Adet

0214CU

0214

Multifunction Tail Lamp

0100

Çok Fonksiyonlu Kuyruk Lambası

Functions Reverse, Stop, Position, Reflector, Rear Fog, Indicator, Num. Plate
Fonksiyonlar Geri Vites, Stop, Pozisyon, Reflektör, Arka Sis, Sinyal, Plaka

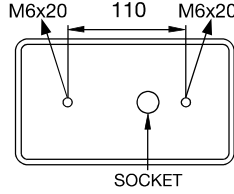
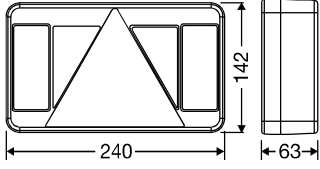

Order Number | Sipariş Kodu

Fastening Bolts | Bağlantı Civataları

Left Sol	Socket Type Bağlantı Tipi	Right Sağ	
0100LL51	With Gromet & Cable (30 cm)	0100LR51	20 pcs Adet
0100LL74	AMP Socket Type	0100LR74	20 pcs Adet

Lens Code | Cam Kodu

0100CL		0100CR		20 pcs Adet
---------------	--	---------------	--	-------------

0171

Functions Reverse, Stop, Rear Fog, Reflector, Indicator, Position, Num. Plate
Fonksiyonlar Geri Vites, Stop, Arka Sis, Reflektör, Sinyal, Pozisyon, Plaka

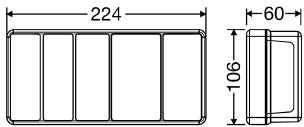

*Without Cable



Order Number | Sipariş Kodu

		15 pcs Adet	
Left Sol			Right Sağ
0171LL			0171LR

Lens Code | Cam Kodu

		15 pcs Adet	
0171CL			0171CR

0254

MODEL: AFTER 2011

Multifunction Tail Lamp

Çok Fonksiyonlu Kuyruk Lambası



Functions Reverse, Stop, Side Marker, Position, Reflector, Rear Fog, Indicator, Num. Plate, End-Outline Marker

Fonksiyonlar Geri Vites, Stop, Yan Marker, Pozisyon, Reflektör, Arka Sis, Sinyal, Plaka, Uç Yan Marker

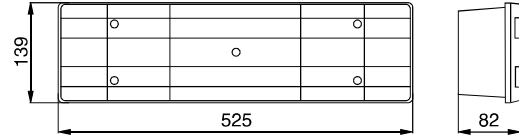

Order Number | Sipariş Kodu



Left
Sol

0254LL7427



Right
Sağ

0254LR7427



With Buzzer
Buzzerli

0254LR7427B



20 pcs Adet



18 pcs Adet

Lens Code | Cam Kodu



0254CL



0254CR



20 pcs Adet

Fastening Bolts | Bağlantı Civataları

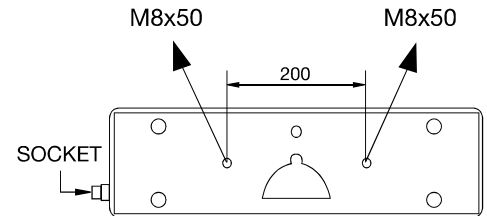

Conn. Points	Sol/Left		Sağ/Right		
	Fonksiyonlar	Functions	Fonksiyonlar	Functions	
1	Şase	Earth	1	Şase	Earth
2	Pozisyon	Position	2	Pozisyon	Position
3	Geri Vites	Reverse	3	Geri Vites	Reverse
4	Sinyal	Signal	4	Sinyal	Signal
5	Stop	Stop	5	Stop	Stop
6	Sis	Fog	6	Boş	Not Used
7	Yedek	Auxiliary	7	Boş	Not Used

Multifunction Tail Lamp

Çok Fonksiyonlu Kuyruk Lambası

0254

Functions Reverse, Stop, Side Marker, Position, Reflector, Rear Fog, Indicator, Num. Plate, End-Outline Marker

Fonksiyonlar Geri Vites, Stop, Yan Marker, Pozisyon, Reflektör, Arka Sis, Sinyal, Plaka, Uç Yan Marker

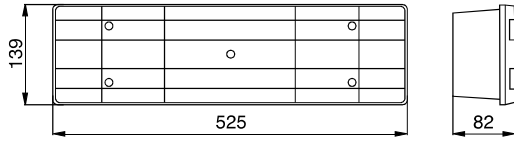

Order Number | Sipariş Kodu



Left
Sol

0254LL742



Right
Sağ

0254LR742



With Buzzer
Buzzerli

0254LR742B



18 pcs Adet



18 pcs Adet

Lens Code | Cam Kodu



0254CL



0254CR



20 pcs Adet

Fastening Bolts | Bağlantı Civataları

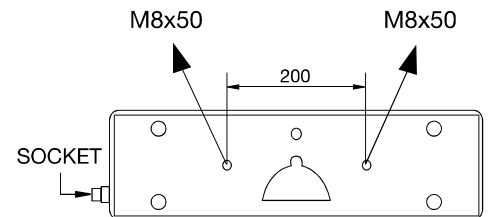

0254

Multifunction Tail Lamp
Çok Fonksiyonlu Kuyruk Lambası



Functions	Reverse, Stop, Side Marker, Position, Reflector, Rear Fog, Indicator, Num. Plate, End-Outline Marker
Fonksiyonlar	Geri Vites, Stop, Yan Marker, Pozisyon, Reflektör, Arka Sis, Sinyal, Plaka, Uç Yan Marker

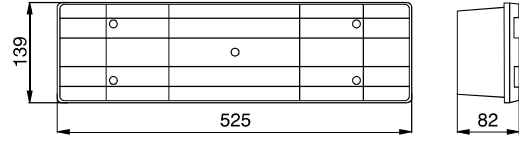

Order Number | Sipariş Kodu



Left
Sol

Right
Sağ

With Buzzer
Buzzerli

0254LL61 (with 30 cm Cable)

0254LR61 (with 30 cm Cable)

0254LR61B (with 30 cm Cable)

0254LL60 (without Cable)

0254LR60 (without Cable)

0254LR60B (without Cable)



18 pcs Adet



18 pcs Adet

Lens Code | Cam Kodu



0254CL

0254CR

Fastening Bolts | Bağlantı Civataları

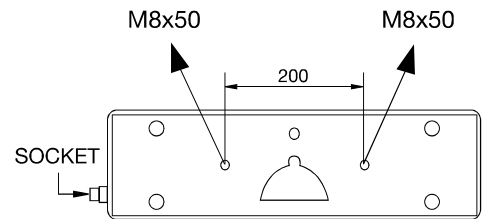

20 pcs Adet

Side Indicator Lamp

Sinyal Lambası

Order Number Sipariş Kodu	
Left Sol	Right Sağ

0248LL**0248LR**

35 pcs Adet

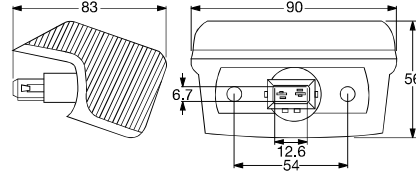

Front Side Indicator Lamp

Ön Kenar Sinyal Lambası

Order Number Sipariş Kodu

0006LUS

35 pcs Adet

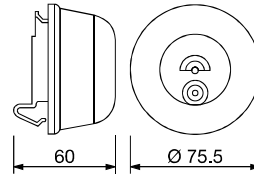

Front Side Indicator Lamp

Ön Kenar Sinyal Lambası

Order Number Sipariş Kodu

0022LU

35 pcs Adet

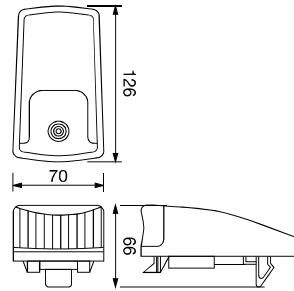

Bus Indicator Lamp

Otobüs Sinyal Lambası

Order Number Sipariş Kodu	Lens Code Cam Kodu
------------------------------	-----------------------

0263LUS**0263CUS**

44 pcs Adet

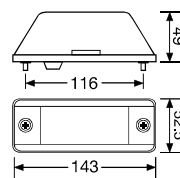



Right | Sağ



Left | Sol



Headlight
Far

Order Number | Sipariş Kodu

Left Sol	Left Glass Sol Cam	Right Sağ	Right Glass Sağ Cam
-------------	-----------------------	--------------	------------------------

0369FL 0369SCL 0369FR 0369SCR

1 pc Adet



Right | Sağ



Left | Sol



Front Lamp
Ön Lambası

Order Number | Sipariş Kodu

Without Socket Left Sol Soketsiz	Without Socket Right Sağ Soketsiz	With Socket Left Sol Soketli	With Socket Right Sağ Soketli
----------------------------------------	-----------------------------------------	------------------------------------	-------------------------------------

0364LGL 0364LGR 0364LL 0364LR

13 pcs Adet

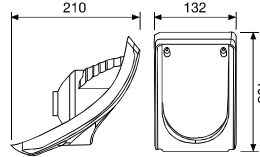

Bus Rear Corner Lamp
Otobüs Arka Köşe Lambası

Order Number | Sipariş Kodu

Position and Stop Pozisyon ve Stop	Indicator Sinyal	Reverse Geri Vites
---------------------------------------	---------------------	-----------------------

0252LUK 0252LUS 0252LUB

20 pcs Adet

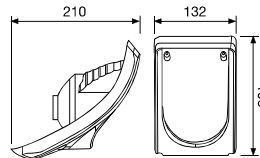

Bus Rear Corner Lamp (with LED)
Otobüs Arka Köşe Lambası (LEDli)

Order Number | Sipariş Kodu

Position Pozisyon	Fog Sis	Indicator Sinyal
---------------------	-----------	--------------------

0252LLEDKP 0252LLEDKS 0252LLEDS

Order Number | Sipariş Kodu

Stop Stop	Reverse Geri Vites
-------------	----------------------

0252LLEDK 0252LLEDB

20 pcs Adet

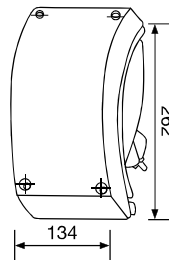

Corner Lamp for Bus
Otobüs Köşe Lambası

Order Number | Sipariş Kodu

Amber Amber	Red Kırmızı	Clear Şeffaf
---------------	---------------	----------------

0183LUS 0183LUK 0183LUB

Order Number | Sipariş Kodu

Lens (Amber) Cam (Amber)	Lens (Red) Cam (Kırmızı)	Lens (Clear) Cam (Şeffaf)
-----------------------------	-----------------------------	------------------------------

0183CUS 0183CUK 0183CUB

20 pcs Adet

Front, Rear Mudguard Panel Front Left
Ön Çamurluk, Ön Parça Sol
Order No: **9803PDM**



Similar Ref. : 20372064
Replaces Volvo

Front, Rear Mudguard Panel Front Right
Ön Çamurluk, Ön Parça Sağ
Order No: **9804PDM**



Similar Ref. : 20372065
Replaces Volvo

Rear Mudguard Panel Middle Part
Arka Çamurluk Orta Parça
Order No: **9802PDM**



Similar Ref. : 20722652/1079965/3171391
Replaces Volvo

Rear Mudguard Panel Front / Back
Arka Çamurluk Ön veya Arka Parça
Order No: **9801PDM**



Similar Ref. : 20392544
Replaces Volvo

Front Wheel Rear Mudguard
Ön Tekerlek Arka Yastık
Order No: **9808.P.DM**



Similar Ref. : 20453900
Replaces Volvo

Rear Front Mudguard (New Type)
Arka Ön Çamurluk (Yeni Tip)
Order No: **9819PDM**



Similar Ref. : 21094394
Replaces Volvo

Step Panel | Basamak Paneli

Order No:
9807PDMR (Right)
9807PDML (Left)



Replaces Volvo

Upper Step Big Type
Metal Büyük Basamak

Order No: **9701MDM**



Similar Ref. : 819315-20379439
Replaces Volvo

Lower Step Small Type
Metal Küçük Basamak

Order No:
9702MDMR (Right)
9702MDML (Left)



Similar Ref. :
20360788 (Left)
20360789 (Right)
Replaces Volvo

Rear Mudguard Panel Middle Part
Orta Çamurluk Parçası

Order No: **9805PDM**



Similar Ref. : 1395276
Replaces Scania

Rear Mudguard Panel Front / Rear
Arka Çamurluk Ön veya Arka Parça

Order No:
9806P1DM



Replaces Scania

Upper Step
Üst Basamak

Order No: **9706MDM**



Similar Ref. : 131203
Replaces Scania

Lower Step
Küçük Basamak

Order No: **9707MDM**



Similar Ref. : 1390076
Replaces Scania

Rear Half Mudguard
Arka Yarım Çamurluk

Order No:
9813PDM (Right)
9816PDM (Left)



Similar Ref. : 5010314953
Replaces Renault

Rear Mudguard Left
Arka Çamurluk Sol

Order No: **9818PDML**



Similar Ref. : 5001856195 / 81664100462
Replaces Renault PM / Man TGA

Mudguard (Middle)
Çamurluk (Orta)

Order No : **9814PDM**



Similar Ref. : 9305200007
Replaces Mercedes Benz

Mudguard (Rear)
Çamurluk (Arka)

Order No : **9823PDM**



Similar Ref. : 9305200020 (Left) / 9305200120 (Right)
Replaces Mercedes Benz

Front Mudguard Front Left
Ön Üst Çamurluk Sol

Order No : **9824PDML**



Similar Ref. : 9305200020
Replaces Mercedes Benz

Front Mudguard Front Right
Ön Üst Çamurluk Sağ

Order No : **9824PDMR**



Similar Ref. : 9305200119
Replaces Mercedes Benz

Mudguard
Çamurluk

Order No : **9815PDM**



Similar Ref. : 816641065743 / 81664106574
Replaces Man TGA

Rear Mudguard Rear Right
Arka Çamurluk (Sağ)

Order No : **9818PDMR**



Similar Ref. : 81664100462 / 5001856195
Replaces Man TGA / Renault PM

Rear Mudguard Panel Rear Part
Arka Çamurluk Paneli Arka Bölümü

Order No : **1311**



Replaces Ford Cargo

Rear Mudguard Central
Arka Orta Çamurluk

Order No : **1310**



Similar Ref. : 9305200140
Replaces Ford Cargo

Rear Mudguard Central
Arka Orta Çamurluk

Order No :
9809PDM



Similar Ref. : 81664106086
Replaces MAN

Rear Mudguard Panel Rear Part Right/Left Mounting
Arka Çamurluk Paneli Sağ/Sol Arka Montajlı

Order No :
9812PDM (Left)
9811PDM (Right)



Similar Ref. : 81664100172
81664100173
Replaces MAN

Rear Mudguard Cap
Arka Çamurluk Kapağı
Order No : **1308L** (Left)
1308R (Right)



Rear Mudguard Sheet Clamp
Arka Çamurluk Kelepçesi
Order No : **1311YL69-ST5**
1311YR69-ST5



Rear Mudguard Fitting Part
Arka Çamurluk Bağlantı Plastiği
Order No : **1310YU41-ST5**

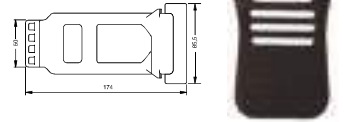

Rear Mudguard Panel Front Part
Arka Çamurluk Paneli Ön Kısım

Order No :
9820PDM



Similar Ref. : 81664100293 / 81664100294
Replaces MAN

High Type Cabin Lower Step
Yüksek Tip Kabin Alt Basamağı
Order No :
9703LP1DM (Left)
9703RP1DM (Right)



Similar Ref. : 5010544026 (Left)
5010544027 (Right) Replaces Renault

High Type Cabin Upper Step
Yüksek Tip Kabin Üst Basamağı
Order No :
9703LP2DM (Left)
9703RP2DM (Right)



Similar Ref. : 5010544029 (Left)
5010544030 (Right) Replaces Renault

Lower Step
Alt Basamak
Order No :
9705PDM



Similar Ref. : 5010225181
Replaces Renault

Upper Step
Üst Basamak
Order No :
9704MDM



Similar Ref. : 5010225398
Replaces Renault

Amber Rotating Beacon with Rod Mounted 12/24V
Çubuğa Monteli Sarı Döner Lamba 12/24V

Order Number Sipariş Kodu	Lens Code Cam Kodu
------------------------------	-----------------------

0315LUS12V
0315LUS12-24V

0315CUS

20 pcs Adet	
-------------	--

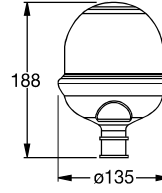

12V/24V



Amber Rotating Beacon 12/24V
Döner Lamba 12/24V

Order Number Sipariş Kodu	Lens Code Cam Kodu
------------------------------	-----------------------

0278LUS12V
0209LUS12-24V

0322CUS

20 pcs Adet	
-------------	--

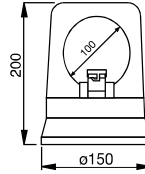

12V/24V



Amber Rotating Beacon with Magnetisid Housing
(Single Pole lighter Plug) 12/24V
Mıknatısla Monteli Sarı Döner Lamba
(Çakmak Fişlerine Uyumlu) 12/24V

Order Number Sipariş Kodu	Lens Code Cam Kodu
------------------------------	-----------------------

0269LUS12V
0271LUS12-24V

0322CUS

10 pcs Adet	
-------------	--

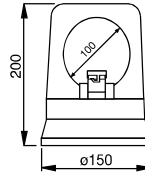

12V/24V



Amber Rotating Beacon with Rod Mounted 12/24V
Çubuğa Monteli Sarı Döner Lamba 12/24V

Order Number Sipariş Kodu	Lens Code Cam Kodu
------------------------------	-----------------------

0322LUS12V
0323LUS12-24V

0322CUS

30 pcs Adet	
-------------	--

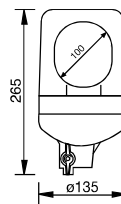

12V/24V



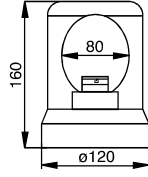

12V/24V



Amber Rotating Beacon Mirror Arm Mounted 12/24V
Arka Koluna Monteli Sarı Döner Lamba 12/24V

Order Number
Sipariş Kodu

Lens Code
Cam Kodu

0312LUS12V
0312LUS12-24V

0311CUS

30 pcs Adet

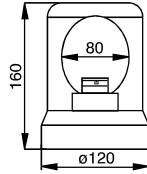

12V/24V



Amber Rotating Beacon with Magnetisid Housing
(Single Pole lighter Plug) 12/24V
Mıknatısla Monteli Sarı Döner Lamba
(Çakmak Fişlerine Uyumlu) 12/24V

Order Number
Sipariş Kodu

Lens Code
Cam Kodu

0311LUS12V
0311LUS12-24V

0311CUS

30 pcs Adet

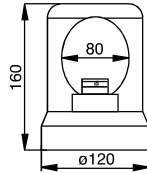

12V/24V



Amber Rotating Beacon with Three Bolts Mounted 12/24V
Üç Civatayla Monteli Sarı Döner Lamba 12/24V

Order Number
Sipariş Kodu

Lens Code
Cam Kodu

0310LUS12V
0310LUS12-24V

0311CUS

30 pcs Adet

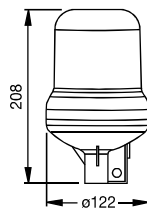

12V/24V



Amber Rotating Beacon with Rod Mounted 12/24V
Çubuğa Monteli Sarı Döner Lamba 12/24V

Order Number
Sipariş Kodu

Lens Code
Cam Kodu

0313LUS12V
0313LUS12-24V

0311CUS

30 pcs Adet

12/24V LEDs Flashing Light
Mounting with Magnetic Base and Mounting with Screw

Mıknatısla Monteli Elips Yüzeyle Döner Lamba 12/24V
Manyetik Tabanlı Montaj ve Vidalı Montaj

Order Number Sipariş Kodu	
Magnetic Mıknatıslı	Screw Vidalı
0318LUS-M	0318LUS-V
20 pcs Adet	

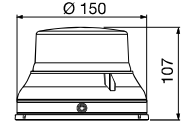
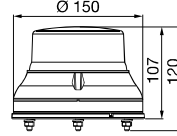

LED Flashing Lamp 12V
LEDli Çakar Lamba 12V

Order Number Sipariş Kodu
0316LUS
54 pcs Adet

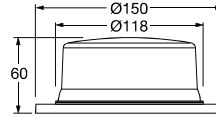

Rotating Beacon Standart Galaxy Type 12/24V
Galaxy Tip Standart Döner Lamba 12/24V

Order Number Sipariş Kodu	Lens Code Cam Kodu
0233LUS12V 0234LUS12-24V	0233CUS
24 pcs Adet	

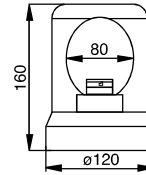

Rotating Beacon Super Galaxy Type 12/24V
Süper Galaxy Tip Döner Lamba 12/24V

Order Number Sipariş Kodu	Lens Code Cam Kodu
0289LUS12V 0232LUS12-24V	0289CUS
16 pcs Adet	

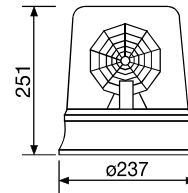

(for rotating beacons)

Order No : **0352U**



100 pcs Adet

Order No : **0354U**



100 pcs Adet

Order No : **0353U**



100 pcs Adet

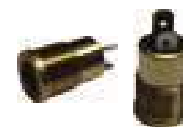

Galaxy Terminal Socket
Order No : **0354Y51J**



200 pcs Adet

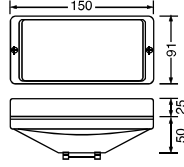

Work Lamp

Çalışma Lambası

Order Number
Sipariş Kodu

5113L

40 pcs Adet

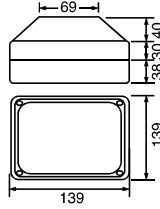

Work Lamp

Çalışma Lambası

Order Number
Sipariş Kodu

5112L

24 pcs Adet

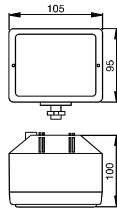

Work Lamp

Çalışma Lambası

Order Number
Sipariş Kodu

DM909HIN

40 pcs Adet



Projector HeadLamp with Parking Light Fog and Driving Type Available
Projektör Lambası (Park Işıklı) Sis ve Yol Sürüş Aydınlatma Tipleri Mevcut

Order Number | Sipariş Kodu

Ø 200 mm

Ø 200 mm

5017LUB

5020LUB



24 pcs Adet

Amber colour also available

Daytime Running Lamp
Gündüz Sürüş Lambası



Functions Front Position, Daytime Running
Fonksiyonlar Ön Pozisyon, Gündüz Sürüş

Order Number
Sipariş Kodu

5018L

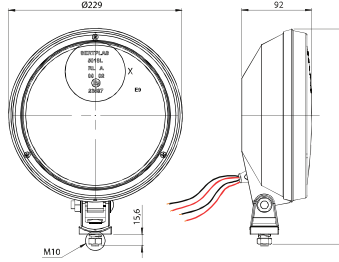

Cable Length Kablo Uzunluğu 20 cm

5 pcs Adet



Reversing Lamp with LED
LED'li Geri Vites Lambası

Order Number | Sipariş Kodu

1 LED

3 LEDs

5114L

5115L

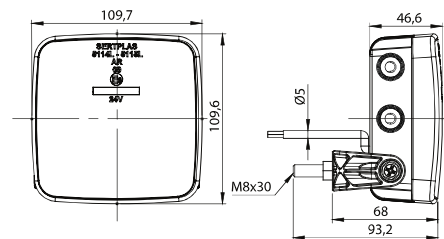

Cable Length Kablo Uzunluğu 200 cm

40 pcs Adet



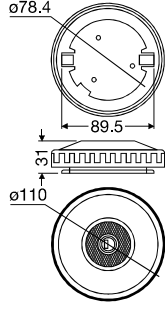

Cast Aluminium
Chrome Plated
Ø80 mm

Locking Tank Cap
Anahtarlı Depo Kapağı

Order Number
Sipariş Kodu

DM7060.YD



(with Chain)

New Type Tank Cap (Ø80 mm)
Zincirli Korumalı Depo Kapağı

Order Number
Sipariş Kodu

DM7061.YD



Locking Tank Cap (Ø80 mm) | Anahtarlı Depo Kapağı

Order Number
Sipariş Kodu

DM7085.YD

With Cover
Koruyuculu

DM7086.YD



Tank Cap | Kilitsiz Depo Kapağı

Order Number
Sipariş Kodu

DM7080.YD



Locking Tank Cap (Ø80 mm) | Anahtarlı Depo Kapağı

Order Number | Sipariş Kodu

DM7070.YD

Aluminium Cast, Black Plated



Locking Tank Cap (Ø60 mm), Plastic Housing
Anahtarlı Depo Kapağı

Order Number | Sipariş Kodu

M7160



Locking Tank Cap (Ø60 mm) | Anahtarlı Depo Kapağı

Order Number
Sipariş KoduWith Cover
Koruyuculu**DM7078.YD****DM7079.YD**

Tank Cap (Ø60 mm) | Kilitless Depo Kapağı

Order Number
Sipariş Kodu**DM7077.YD**

Radiator Cap | Radyatör Kapağı

Order Number | Sipariş Kodu

DM7088.YD

Oil Cap | Yağ Kapağı

Order Number | Sipariş Kodu

DM7087.YD

Radiator Cap | Radyatör Kapağı

Order Number | Sipariş Kodu

Without Chain | Zincirsiz

With Chain | Zincirli

DM7074.YD**DM7073.YD**

Tire Pump up Hose (Complete) (Air Hose)

Oto Lastik Şişirme Hortumu

Order Number
Sipariş Kodu6 mt. **DM3901-6**16 mt. **DM3901-16**9 mt. **DM3901-9**18 mt. **DM3901-18**12 mt. **DM3901-12**20 mt. **DM3901-20**13 mt. **DM3901-13**24 mt. **DM3901-24**

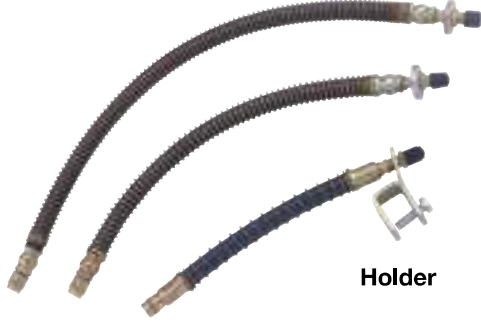
Holder
Air Hose Connection
 Yaylı Tahliye Köprüsü

Order Number Sipariş Kodu	
15 cm 15 cm	25 cm 25 cm
35 cm 35 cm	

DM3902-15
DM3902-25
DM3902-35

Flexible Pipe | Akordeon Boru

Order Number Sipariş Kodu		
Ø76 Ø76	Ø90 Ø90	Ø100 Ø100

DM990126
DM990127
DM990128

Flexible Pipe | Esnek Boru

Order Number Sipariş Kodu	
Ø70-80-90-100-110-115-120-130-140-150	

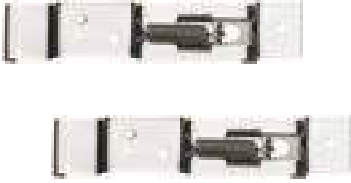
DM990131

Number Plate Holder (Inox) | Plaka Tutucu

Order Number Sipariş Kodu	
2001	

2001

Gress Pump | Gress Pompası

Order Number Sipariş Kodu	
500 CCM	300 CCM

DM990129
DM990130

Emergency Hammer | Acil Yardım Çekici

Order Number Sipariş Kodu	
DM990133	

DM990133

Plastic Nut Cap | Plastik Bijon Kapağı

Order Number Sipariş Kodu	
DM990132/32	DM990132/33

DM990132/32
DM990132/33

STEERING WHEEL KNOB

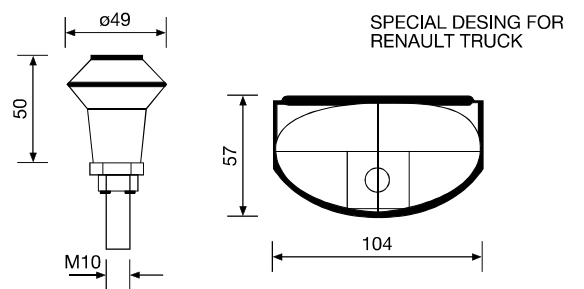
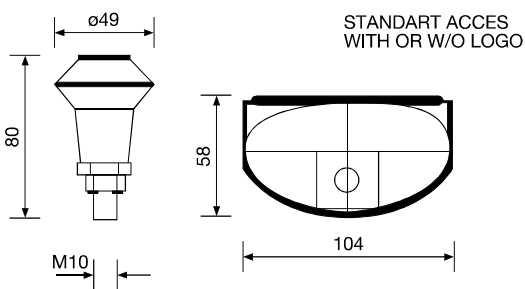

With Logo

- Mercedes **0455UMER**
- Scania **0455USCA**
- Volvo **0455UVOL**
- Man **0455UMAN**
- Renault **0455UREN**
- Iveco **0455UIVE**
- Trucker **0455UTRU**
- Europa **0455UEUR**
- Fiat **0455UFIAT**

W/o Logo

- 0427USTD** Chrome plated
- 0427USTDZ** Black painted

Packing

- * Single unit in a box with or w/o window
- * 12 each in a box with seperator sheet
- * 30 each in a box with seperator sheet
- * 100 unit boxes in one cartoon-box



T.I.R Battery Isolator Switch (Circuit Breaker)
Tır Devre Kesici (Ağır Tip)

Order Number
Sipariş Kodu

E2323BM

Max Current: 200 Ampere



Caravan Battery Isolator Switch (Circuit Breaker) 12V
Karavan Tipi Devre Kesici

Order Number
Sipariş Kodu

E2319B

Max Current: 100 Ampere

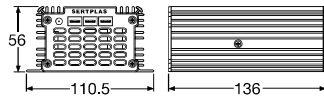

Switch Mode Converter
Konvertör

Order Number
Sipariş Kodu

K2980

24V/12V 20 Ampere
Input Voltage: 18-32V
Output Voltage: 13,3V



30 pcs Adet

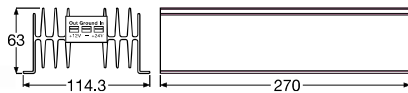

Converter
Konvertör

Order Number
Sipariş Kodu

K2979

24V/12V 20 Ampere
Power : 240W
Input voltage : 18-32V
Output voltage : 13,5V



15 pcs Adet

Converter

Konvertör

Order Number
Sipariş Kodu

K2978

19 pcs Adet

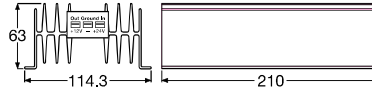

24V/12V 15 Ampere
Power : 180W
Input voltage : 18-32V
Output voltage : 13,5V



Converter

Konvertör

Order Number
Sipariş Kodu

K2977

20 pcs Adet

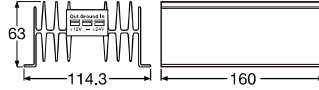

24V/12V 10 Ampere
Power : 120W
Input voltage : 18-32V
Output voltage : 13,5V



Converter

Konvertör

Order Number
Sipariş Kodu

K2976

20 pcs Adet

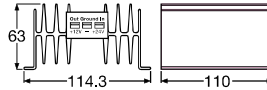

24V/12V 5 Ampere
Power : 60W
Input voltage : 18-32V
Output voltage : 13,5V



Electronic Ballast for Fluorescent Cabin Lights (24V)
Balast Elektronik (24V)

Order Number
Sipariş Kodu

**K2069**

100 pcs Adet

24 V. DC/08A
18 W.....40 W



Damper Lifting Switch (One Position)
Damper Kaldırma Düğmesi (Tek Pozisyonlu)

Order Number
Sipariş Kodu

IPR90019

Damper Lifting Switch
(One Position)
Damper Kaldırma Düğmesi
(Çift Pozisyonlu)



Order Number
Sipariş Kodu

IPR90018

Termal Switch Sensor
Termal Anahtar Sensörü



Order Number
Sipariş Kodu

DMIRD12074



Heavy Duty
Complete Set (5m)
Different lengths also available.



Starter Cable (Red&Black)

Akü Takviye Kablo Takımı (Kırmızı&Siyah)

Order Number
Sipariş Kodu

E2688EKL

5 pcs Adet



Battery Clips Standard Type (Red&Black Colours)

Akü Takviye Maşası (Kırmızı&Siyah renklerde)

Order Number | Sipariş Kodu

Red | Kırmızı

Black | Siyah

E2686EYK

E2686EYZ



100 pcs Adet



New Type Single Pole Lighter Plug
Yeni Tip Tek Kutuplu Çakmak Fişi

Order Number | Sipariş Kodu

1022



Long Flasher

Uzun Flaşör

Niles Type

Order Number | Sipariş Kodu

12V

24V

K5498FR

K5588FR



Junction Box | Klemens Kutusu

Order Number | Sipariş Kodu

2243SSx6

6 Screw Connection / 6 Vida Bağlantılı

2243SSx8

8 Screw Connection / 8 Vida Bağlantılı

2243SSx10

10 Screw Connection / 10 Vida Bağlantılı

Right Bumper
Sağ Tampon

Order Number Sipariş Kodu	
Left Sol	Right Sağ

1306L

1306R

Order Number Sipariş Kodu	
With Fog Lamp Hole Sis Far Delikli	
Left Sol	Right Sağ

1306LQ

1306RQ



Right | Sağ

Left | Sol

Grill Bumper
Ön Panjur

Order Number Sipariş Kodu

1305



Front Lamp
Ön Lamba

Order Number Sipariş Kodu

DM0519L



Front Signal Lamp (without Socket)
Ön Sinyal Lambası (Soketsiz)

Order Number Sipariş Kodu	
Left Sol	Right Sağ

0516LL

0516LR

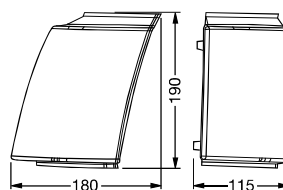

40 pcs Adet



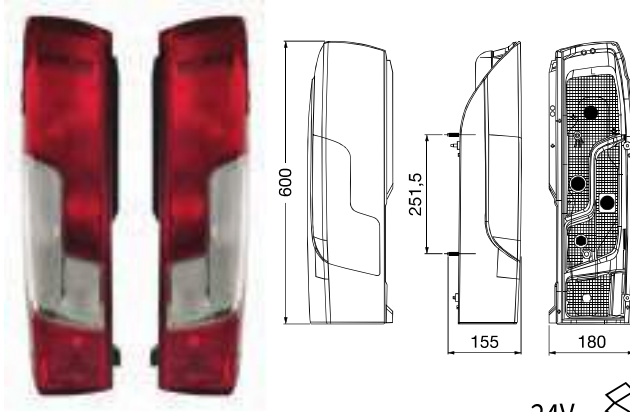

Rear Combination Lamp (without Socket)
Arka Kombinasyon Lambası (Soketsiz)

Order Number | Sipariş Kodu

Left | Sol

Right | Sağ

0526LL

0526LR

10 pcs Adet



24V

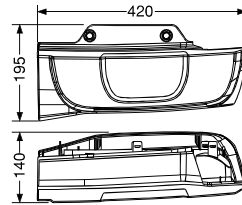

Rear Combination Lamp (without Socket)
Arka Kombinasyon Lambası (Soketsiz)

Order Number | Sipariş Kodu

Horizontal Door
Yatay Kapı

Vertical Door
Dikey Kapı

0368LL (Left)

0373LL (Left)

0368LR (Right)

0373LR (Right)

14 pcs Adet

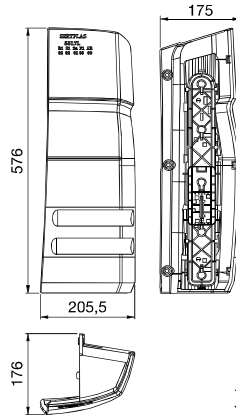

Rear Combination Lamp (without Socket)
Arka Kombinasyon Lambası (Soketsiz)

Order Number | Sipariş Kodu

Left | Sol

Right | Sağ

5517LL

5517LR

10 pcs Adet

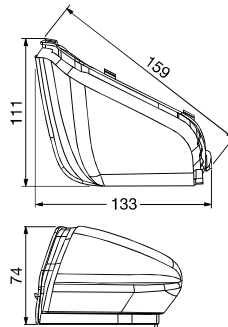

Outside Mirror-Indicator Lamp (With Bulb)
Kapı Aynası Sinyal Lambası

Order Number | Sipariş Kodu

Left | Sol

Right | Sağ

0527LL

0527LR

25 pcs Adet



Bulb Holder : QSK64-STŞ



Rear Combination Lamp
(without Socket)

Arka Kombinasyon Lambası (Soketsiz)

Order Number Sipariş Kodu	
Left Sol	Right Sağ

0342LL

0342LR

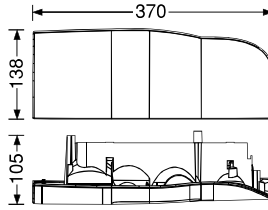

16 pcs Adet



Rear Combination Lamp
(without Socket)

Arka Kombinasyon Lambası (Soketsiz)

Order Number Sipariş Kodu	
Left Sol	Right Sağ

0515LL

0515LR

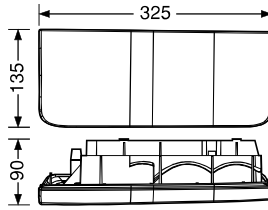

18 pcs Adet



Rear Combination Lamp
(without Socket)

Arka Kombinasyon Lambası (Soketsiz)

Order Number Sipariş Kodu	
Left Sol	Right Sağ

0343LL

0343LR

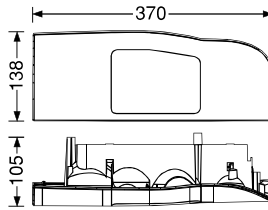

16 pcs Adet



Rear Tail Lamp
(without Socket)

Arka Kuyruk Lambası (Soketsiz)

Order Number Sipariş Kodu	
Left Sol	Right Sağ

DM0524LL

DM0524LR

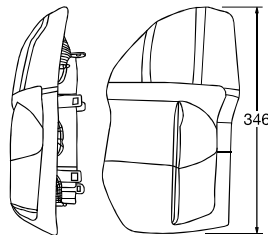

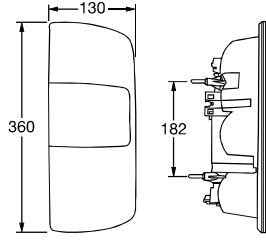

Tail Lamp (without Socket)
Kuyruk Lambası (Soketsiz)

Order Number Sipariş Kodu	
Left Sol	Right Sağ

DM0518LL

DM0518LR

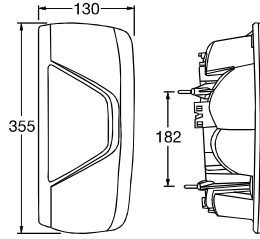

Tail Lamp (without Socket)
Kuyruk Lambası (Soketsiz)

Order Number Sipariş Kodu	
Left Sol	Right Sağ

DM0520LL

DM0520LR

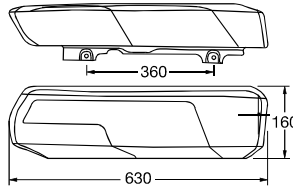

Bus Tail Lamp
Otobüs Kuyruk Lambası

Order Number Sipariş Kodu	
Left Sol	Right Sağ

DM0521LL

DM0521LR

Socket Code Soket Kodu	
Left Sol	Right Sağ

QDY54L-STŞ

QDY54R-STŞ

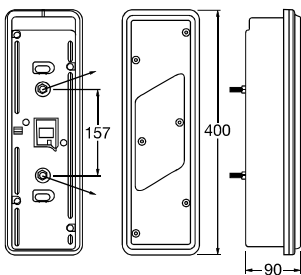

Tail Lamp
(without Socket)
Kuyruk Lambası (Soketsiz)

Order Number Sipariş Kodu	
Left Sol	Right Sağ

DM0523LL

DM0523LR



Side Indicator Lamp (Includes bulb holder)
Yan Sinyal Lambası (Duylu)

Order Number Sipariş Kodu	
Left Sol	Right Sağ
0243LL	0243LR
18 pcs Adet	

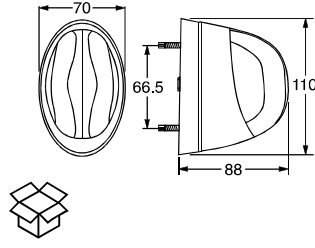

Outside Mirror-Indicator Lamp
(without Socket)
Kapı Aynası Sinyali (Soketsiz)

Order Number Sipariş Kodu	
Left Sol	Right Sağ
DM0348LL	DM0348LR

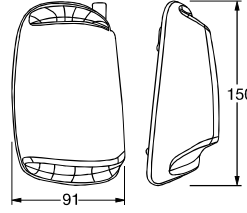

Minibus Tail Lamp
Arka Kuyruk Lambası

Order Number Sipariş Kodu	Lens Code Cam Kodu
0069LU	0069CU
18 pcs Adet	

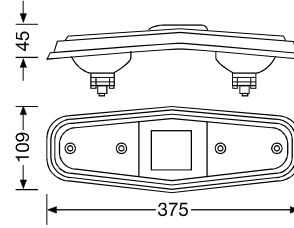

Minibus Front Signal | Minibüs Ön Sinyal

Order Number Sipariş Kodu
1142CU



Front Signal Lamp | Ön Sinyal Lambası

Order Number Sipariş Kodu	
Left Sol	Right Sağ
DM0244LL	DM0244LR

Rear Lamp for Bus
Otobüs Arka Lambası

Order Number Sipariş Kodu		
Clear Şeffaf	Red Kırmızı	Amber Amber
0222LUB	0222LUK	0222LUS
Order Number Sipariş Kodu		
Lens (Clear) Cam (Şeffaf)	Lens (Red) Cam (Kırmızı)	Lens (Amber) Cam (Amber)
0222CUB	0222CUK	0222CUS

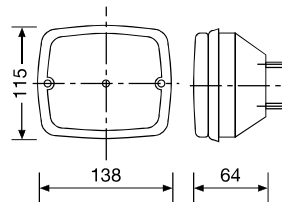



Tail Lamp | Kuyruk Lambası

Order Number | Sipariş Kodu

Left | Sol

Right | Sağ

0053LL

0053LR

Lens Code | Cam Kodu

Left | Sol

Right | Sağ

0053CL

0053CR

Tail Stop and Signal Lamp
Kuyruk Stop ve Sinyal Lambası

Order Number | Sipariş Kodu

Left | Sol

Right | Sağ

DM0245LL

DM0245LR



Tail Lens
Kuyruk Camı

Order Number | Sipariş Kodu

Left | Sol

Right | Sağ

1208CLSK

1208CLSB



Tail Lens
Kuyruk Camı

Order Number
Sipariş Kodu

1207CU

15 pcs Adet



Tail Lens
Kuyruk Camı

Order Number
Sipariş Kodu

1141CUSK



Signal Lamp | Sinyal Lambası

Order Number
Sipariş Kodu

0255LU

Lens Code
Cam Kodu

0255CU



40 pcs Adet



Grill | Panjur

Order Number | Sipariş Kodu

0841P



Indoor Ceiling Lamp with LED
LED' li İç Tavan Lambası

Order Number | Sipariş Kodu

0502L

OE Code	Order No	Product Group	OE Code	Order No	Product Group	OE Code	Order No	Product Group
5-5000-501	0020CL	Rear Lamp	1284212	000LL75	Rear Lamp	4806773	0153LL5K71	Rear Lamp
5-5400-501	0020CR	Rear Lamp	1304789	000LL75	Rear Lamp	4705756	0153LRSB71	Rear Lamp
5-5100-507	0020L50Q	Rear Lamp	1200948	000LR72	Rear Lamp	4808772	0153LRSB71	Rear Lamp
5-5000-507	0020L73Q	Rear Lamp	1284214	000LN72	Rear Lamp	3507321	020SL51	Rear Lamp
5-5000-507	0020LR50Q	Rear Lamp	1000348	000LR72T	Rear Lamp	1353020000	006LR	Rear Lamp
5-5400-507	0020LR73Q	Rear Lamp	1284214	000LR72T	Rear Lamp	1358040000	0373LR	Rear Lamp
5-6000-501	0002CL	Rear Lamp	1625086	000LR74Z	Rear Lamp	1358250000	0373LR	Rear Lamp
5-6400-501	0002CR	Rear Lamp	1625086	000LR74ZT1	Rear Lamp	42024000	000LL	Rear Lamp Round
5-6001-507	0002L73	Rear Lamp	1284211	000LR75	Rear Lamp	2780714	006RLUS24V	Revolving Warning Light
5-6011-517	0002L73Q25	Rear Lamp	1304788	000LR75	Rear Lamp	2780813	0022LUS24V	Revolving Warning Light
5-6401-507	0002LR72	Rear Lamp	1284211	000LR75	Rear Lamp	92C72A138AA	F3820H19K16	Air Hose
5-6411-517	0002LR73Q26	Rear Lamp	1304788	000LR75	Rear Lamp	92C72A138AA	F3820H19K16	Air Hose
5-2801-707	0050LL	Rear Lamp	086 6217	002CU	Rear Lamp	81 817 390	E3806FK	Plug / Socket
5-3800-507	0050LL	Rear Lamp	152 2390	0051L	Rear Lamp	810813A4508A	E3807FK	Plug / Socket
5-3800-517	0050LL	Rear Lamp	152 2390	0031LH	Rear Lamp	98C114K098AA	EN3817	Plug / Socket
5-3820-517	0050L D1L	Rear Lamp	0667564	0196CUK9	Rear Lamp	V96CT13465AA	020SL51	Rear Lamp
5-3820-517	0050L D1R	Rear Lamp	066 7574	0196CUS8	Rear Lamp	V96CT13464AA	020SLP51	Rear Lamp
5-2901-707	0050LR	Rear Lamp	086 1401	0196LLRSB60	Rear Lamp	9H615K2018A	036LLED	Rear Lamp Round
5-3000-507	0050LR	Rear Lamp	086 7462	0196LLRSB60	Rear Lamp	V1C4415T038AA	0022LUS24V	Revolving Warning Light
5-3000-517	0050LR	Rear Lamp	090 6570	0196LLRSB60	Rear Lamp	8C46 130576 AA	E4215FH40	Socket Cable
5-2800-507	0051LL73	Rear Lamp	090 6574	0196LLRSB60	Rear Lamp	8C46130576AA	E4215FH40	Socket Cable
5-2810-507	0051LL73Q1	Rear Lamp	152 7012	0196LLRSB60	Rear Lamp	98C114K097AA	E382CF105	Socket Cable
5-2900-507	0051LR73	Rear Lamp	087 9180	0196LLS860	Rear Lamp	1485774	1305	Grid Bumper
5-2910-507	0051L D73Q1	Rear Lamp	088 0195	0196LR5860	Rear Lamp	1529974	1305	Grid Bumper
5-2910-507	0051L D73Q1	Rear Lamp	1527013	0196LR5860	Rear Lamp	1709131	1305	Grid Bumper
6050JH	0068LR	Rear Lamp	143 5134	0005CU	Rear Lamp	1 102 374	0340LL	Rear Lamp
6051ET	0073LR	Rear Lamp	136 3654	0005L51	Rear Lamp	1 113 577	0340LL	Rear Lamp
6050ET	0073LR	Rear Lamp	136 3654	0005L51	Rear Lamp	1 115 630	0340LL	Rear Lamp
1504 901	F3820K18	Air Couplings	0888663	022CU08	Rear Lamp	1 205 706	0340LL	Rear Lamp
1504951	F3820K18	Air Couplings	0292052	022LLR60	Rear Lamp	4 041 627	0340LL	Rear Lamp
1427 369	F3820K20	Air Couplings	0292054	022LLR60	Rear Lamp	YC15 1340S AD	0340LL	Rear Lamp
1427369	F3820K22	Air Couplings	086 7574	028AA	Rear Lamp	YC15 1340S AE	0340LL	Rear Lamp
0879137	F3820H19K18	Air Hose	0563048	030LLED	Rear Lamp Round	YC15 1340S AF	0340LL	Rear Lamp
0879138	F3820H19K18	Air Hose	563048	030LLED	Rear Lamp Round	YC15 1340S AG	0340LL	Rear Lamp
0906118	F3820H19K18	Air Hose	627 235	0361LLED	Rear Lamp Round	YC1X 13451 AD	0340LL	Rear Lamp
0906120	F3820H19K18	Air Hose	056 3047	038LL	Rear Lamp Round	1 102 373	0340LR	Rear Lamp
0906121	F3820H19K18	Air Hose	154 4058	0096LUS24V	Revolving Warning	1 113 574	0340LR	Rear Lamp
1518048	F3820H19K18	Air Hose	090 6547	0271LUS24V	Revolving Warning	1 116 629	0340LR	Rear Lamp
1518048	F3820H19K18	Air Hose	161 6169	0276LUS12V	Revolving Warning	1 205 701	0340LR	Rear Lamp
0867930	0250LEDZ	License Plate Light	090 6541	0315LUS24V	Revolving Warning	2C14 13404 AA	0340LR	Rear Lamp
128 0718	0250LEDZ	License Plate Light	067 2785	0322LUS24V	Revolving Warning	4 041 626	0340LR	Rear Lamp
1374260	0250LEDZ	License Plate Light	080 7228	0322LUS24V	Revolving Warning	4 388 981	0340LR	Rear Lamp
006 7392	0084CLEO	Outline Marker Light	1303892	0338LUS	Side Marker Lamp	YC15 13404 AD	0340LR	Rear Lamp
0064606	0084CLEO	Outline Marker Light	1303892	0338LUS	Side Marker Lamp	YC15 13404 AE	0340LR	Rear Lamp
135 8794	0084CLEO	Outline Marker Light	1329718	0338LUS	Side Marker Lamp	YC15 13404 AF	0340LR	Rear Lamp
904 1381	0084CLEO	Outline Marker Light	1300703	0651LUS	Side Marker Lamp	YC15 13404 AG	0340LR	Rear Lamp
006 7392	0084EMKB	Outline Marker Light	196 3324	0651LUS	Side Marker Lamp	YC15 13404 AH	0340LR	Rear Lamp
0064606	0084EMKB	Outline Marker Light	087 1567	1851LUS	Side Marker Lamp	YC1X 13405 AD	0340LR	Rear Lamp
9 041 381	0084EMKB	Outline Marker Light	1300707	1851LUS	Side Marker Lamp	1 435 881	0340LR	Rear Lamp
904 1381	0084EMKB	Outline Marker Light	152 9488	1851LUS	Side Marker Lamp	6C1113403AA	0340LR	Rear Lamp
135 8193	0084EMKB	Outline Marker Light	1522 914	E4207FH	Socket Cable	1 435 880	0340LR	Rear Lamp
006 7392	0123LEMKB	Outline Marker Light	1623545	E4207FH	Socket Cable	6C1113451AA	0340LR	Rear Lamp
0064606	0123LEMKB	Outline Marker Light	3545 403	E4207FH	Socket Cable	1 044 104	0515LL	Rear Lamp
904 1381	0123LEMKB	Outline Marker Light	887763	E4207FH	Socket Cable	1 072 424	0515LL	Rear Lamp
086 9980	0306LL	Outline Marker Light	1348 218	E4415F3M	Socket Cable	1 651 499	0515LL	Rear Lamp
090 6672	0306LL	Outline Marker Light	1532 917	E4415F3M	Socket Cable	1 641 672	0515LL	Rear Lamp
090 8401	0306LL	Outline Marker Light	1645 452	E4415F3M	Socket Cable	1 641 703	0515LL	Rear Lamp
090 8627	0306LR	Outline Marker Light	1346 218	E4415FH	Socket Cable	4 505 432	0515LL	Rear Lamp
090 8671	0306LR	Outline Marker Light	1532 917	E4415FH	Socket Cable	6 158 264	0515LL	Rear Lamp
090 8452	0306LR	Outline Marker Light	1645 452	E4415FH	Socket Cable	6 161 979	0515LL	Rear Lamp
090 8128	0308LFR	Outline Marker Light	1346 218	E4415FH0U35	Socket Cable	0 186 648	0515LL	Rear Lamp
090 8615	0308LFR	Outline Marker Light	1532 917	E4415FH0U35	Socket Cable	6 200 195	0515LL	Rear Lamp
090 4410	E2317FK	Plug / Socket	1645 492	E4415FH0U35	Socket Cable	6 695 706	0515LL	Rear Lamp
086 7529	E2317FK	Plug / Socket	0867971	EN3853FL05	Socket Cable	7 334 714	0515LL	Rear Lamp
030 4409	E2318FK	Plug / Socket	1485535	EN3853FL05	Socket Cable	86VB 13405 AD1J	0515LL	Rear Lamp
086 7537	E2318FK	Plug / Socket	1843143	EN3853FL05	Socket Cable	86VB 13405 AE	0515LL	Rear Lamp
130 1780	E3826FK	Plug / Socket	867071	EN3853FL05	Socket Cable	86VB 13405 AF	0515LL	Rear Lamp
130 1758	E3827FK	Plug / Socket	0866484	E53853FL05	Socket Cable	86VB 13405 AG	0515LL	Rear Lamp
1374451	E3827FK	Plug / Socket	1367149	E53853FL05	Socket Cable	86VB 13405 AH	0515LL	Rear Lamp
1506 027	E4707FQ1	Plug / Socket	1485 545	E53853FL05	Socket Cable	90VB 13405 AA	0515LL	Rear Lamp
1506027	E4707FQ1	Plug / Socket	1627155	E53853FL05	Socket Cable	90VB 13405 AB	0515LL	Rear Lamp
1606477	E4707FQ1	Plug / Socket	1545496	E53853FL05	Socket Cable	95VG 13405 AA	0515LL	Rear Lamp
0703748	EN3815	Plug / Socket	1840559	E53853FL05	Socket Cable	95VG 13405 AB	0515LL	Rear Lamp
152 7114	EN3815	Plug / Socket	86484	E53853FL05	Socket Cable	95VG 13405 AC	0515LL	Rear Lamp
703748	EN3815	Plug / Socket	000 820 90 56	0250LEDZ	License Plate Light	95VG 13405 AD	0515LL	Rear Lamp
1383002	EN3815	Plug / Socket	2630000001	0250LEDZ	License Plate Light	090VB 13405 AF	0515LL	Rear Lamp
130 1759	EN3817	Plug / Socket	7 544 119 000 0	0250LEDZ	License Plate Light	1 044 103	0515LR	Rear Lamp
152 3685	EN4817	Plug / Socket	011 545 28 28	E2318FK	Plug / Socket	1 072 423	0515LR	Rear Lamp
1284329	E53816	Plug / Socket	370 545 00 28	E4015FQ1	Plug / Socket	1 651 498	0515LR	Rear Lamp
1301755	E54017	Plug / Socket	006 345 06 26	EN3817	Plug / Socket	1 641 701	0515LR	Rear Lamp
086 7491	0084LJ	Rear Lamp	5 530 100 830 1 04	EN3817	Plug / Socket	1 641 702	0515LR	Rear Lamp
152 7012	0084LJ	Rear Lamp	000 820 58 56	0361LLED	Rear Lamp Round	4 505 431	0515LR	Rear Lamp
090 6973	0084LJ	Rear Lamp	6 000 820 25 56	0361LLED	Rear Lamp Round	6 158 263	0515LR	Rear Lamp
090 6974	0084LJ	Rear Lamp	41622554	0250LEDZ	License Plate Light	0 161 978	0515LR	Rear Lamp
086 7492	0084LJ79	Rear Lamp	99445124	0084CLEO	Outline Marker Light	6 186 647	0515LR	Rear Lamp
086 7571	0029CUSK	Rear Lamp	99445126	0084CLEO	Outline Marker Light	6 200 194	0515LR	Rear Lamp
086 2012	0029LR0K00	Rear Lamp	99445124	0084EMKB	Outline Marker Light	6 695 705	0515LR	Rear Lamp
087 4866	0030CU	Rear Lamp	99445126	0084EMKB	Outline Marker Light	7 334 713	0515LR	Rear Lamp
1278653	0030CU	Rear Lamp	99445124	0123LEMKB	Outline Marker Light	86VB 13404 AD1J	0515LR	Rear Lamp
152 4795	0030CU	Rear Lamp	99445126	0123LEMKB	Outline Marker Light	86VB 13404 AE	0515LR	Rear Lamp
1209340	0030LL72	Rear Lamp	8161 7350	E3826FK	Plug / Socket	86VB 13404 AF	0515LR	Rear Lamp
1209340	0030LL72T	Rear Lamp	42013059	0029LRSK00	Rear Lamp	86VB 13404 AG	0515LR	Rear Lamp
13257075	0030LL74Z	Rear Lamp	42013058	0029LRSK00	Rear Lamp	86VB 13404 AH	0515LR	Rear Lamp
1625985	0030LL74Z	Rear Lamp	000000090754	0153CL5K	Rear Lamp	90VB 13404 AA	0515LR	Rear Lamp
13257075	0030LL74ZT	Rear Lamp	7984796	0153CL5K	Rear Lamp	90VB 13404 AB	0515LR	Rear Lamp
1625985	0030LL74ZT	Rear Lamp	7984890	0153CL5K	Rear Lamp	95VG 13404 AA	0515LR	Rear Lamp
1284212	0030LL75	Rear Lamp	7984797	0153CR58	Rear Lamp	95VG 13404 AB	0515LR	Rear Lamp
1304789	0030LL75	Rear Lamp	4785252	0153LL5K71	Rear Lamp	95VG 13404 AC	0515LR	Rear Lamp

OE Code	Order No	Product Group	OE Code	Order No	Product Group	OE Code	Order No	Product Group
50V3 13404 AD	0515LR	Rear Lamp	1904940	0153LLBK71	Rear Lamp	28 12526 0005 81	0123LEMK9	Outline Marker Light
086V9 13404 AF	0515LR	Rear Lamp	1907701	0153LLBK71	Rear Lamp	81 25260 6056	0123LEMK9	Outline Marker Light
4074080	DM0520LL	Rear Lamp	4769138	0153LLBK71	Rear Lamp	81 25430 0175	E2317FK	Plug / Socket
5066908	DM0520LL	Rear Lamp	4808775	0153LLBK71	Rear Lamp	81 25432 6042	2617	Plug / Socket
5108X02	DM0520LL	Rear Lamp	4810329	0153LLBK71	Rear Lamp	81 25435 008 6	EN381E	Plug / Socket
5177813	DM0520LL	Rear Lamp	7567811	0153LLBK71	Rear Lamp	81 25435 0199	EN381S	Plug / Socket
4074082	DM0520LR	Rear Lamp	1904809	0153LRB871	Rear Lamp	33 25432 6019	EN3817	Plug / Socket
5066907	DM0520LR	Rear Lamp	1907700	0153LRB871	Rear Lamp	81 25225 6403	0021LL	Rear Lamp
5103001	DM0520LR	Rear Lamp	4808774	0153LRB871	Rear Lamp	81 25225 6403	0021LR	Rear Lamp
5177810	DM0520LR	Rear Lamp	4810327	0153LRB871	Rear Lamp	28 12527 0005 81	0029CU	Rear Lamp
1815610	DM0521LL	Rear Lamp	7567810	0153LRB871	Rear Lamp	81 25226 0050	0029CUK	Rear Lamp
1822207	DM0521LL	Rear Lamp	4248 0353	0029CU	Rear Lamp	85 20001 0112	0029R9000	Rear Lamp
1829128	DM0521LL	Rear Lamp	41993810E26727-80	0029L80	Rear Lamp	81 25229 6051	0030CU	Rear Lamp
1846554	DM0521LL	Rear Lamp	42013219K25026-80	0029L80	Rear Lamp	81 25229 6052	0030CU	Rear Lamp
1848243	DM0521LL	Rear Lamp	42555131	0294CUB	Rear Lamp	81 25229 6442	0030L72	Rear Lamp
1855335	DM0521LL	Rear Lamp	42555132	0294CUB	Rear Lamp	81 25229 6445	0030L72	Rear Lamp
1870426	DM0521LL	Rear Lamp	5801251219	0294LRB74	Rear Lamp	81 25229 6475	0030L72	Rear Lamp
1815607	DM0521LR	Rear Lamp	5801631438	0294LRB74	Rear Lamp	81 25228 6034	0030L72	Rear Lamp
1822206	DM0521LR	Rear Lamp	89400032	0294LRB74	Rear Lamp	81 25228 6035	0030L72	Rear Lamp
1829125	DM0521LR	Rear Lamp	5801381224	0294LRB874	Rear Lamp	81 25228 6039	0030L72	Rear Lamp
1846553	DM0521LR	Rear Lamp	5801831433	0294LRB874	Rear Lamp	81 25228 6034	0030L72	Rear Lamp
1848242	DM0521LR	Rear Lamp	68500026	0294LRB874	Rear Lamp	81 25228 6036	0030L72	Rear Lamp
1855334	DM0521LR	Rear Lamp	248 1978K23026-80	0361LED	Rear Lamp Round	81 25228 6036	0030L72	Rear Lamp
1870425	DM0521LR	Rear Lamp	2481 978	0361LED	Rear Lamp Round	81 25225 6442	0030L72T	Rear Lamp
1370942	1306L	Side Bumper	4162 2525	0363LED	Rear Lamp Round	81 25225 6445	0030L72T	Rear Lamp
1387149	1306L	Side Bumper	4162 2525E18827-13	0363LED	Rear Lamp Round	81 25225 6475	0030L72T	Rear Lamp
1437326	1306L	Side Bumper	4163 2525	0363LED	Rear Lamp Round	81 25228 6034	0030L72T	Rear Lamp
1370881	1306LQ	Side Bumper	5032 90661	0363LED	Rear Lamp Round	81 25228 6035	0030L72T	Rear Lamp
1387148	1306LQ	Side Bumper	4120 0525	0360L	Rear Lamp Round	81 25228 6039	0030L72T	Rear Lamp
1437082	1306LQ	Side Bumper	4202 4699	0360L	Rear Lamp Round	81 25228 6034	0030L72T	Rear Lamp
1370942	1306R	Side Bumper	5032 94098	0298LUS24V	Revolving Warning	81 25228 6036	0030L72T	Rear Lamp
1387149	1306R	Side Bumper	2780 714	0298LUS24V	Revolving Warning	81 25228 6035	0030L72T	Rear Lamp
1437326	1306R	Side Bumper	0278 0823K23026-80	0322LUS24V	Revolving Warning	81 25225 0119	0030L742	Rear Lamp
1370880	1306RQ	Side Bumper	2780 818	0322LUS24V	Revolving Warning	81 25225 6524	0030L742	Rear Lamp
1387147	1306RQ	Side Bumper	5000500368514	0368LUS	Side Marker Lamp	81 25225 6526	0030L742	Rear Lamp
1437091	1306RQ	Side Bumper	500306514	0368LUS	Side Marker Lamp	81 25225 6485	0030L742	Rear Lamp
2006626	DM0524LL	Rear Lamp	5 0003 7415	EN3853F135	Socket Cable	81 25228 6034	0030L742	Rear Lamp
ET7613404AB	DM0524LR	Rear Lamp	5 0003 7413	EN3853F135	Socket Cable	81 25228 6036	0030L742	Rear Lamp
2009551	DM0524LR	Rear Lamp	500037411	EN3853F135	Socket Cable	81 25225 6519	0030L742T	Rear Lamp
ET7613405AB	DM0524LR	Rear Lamp	500037413	EN3853F135	Socket Cable	81 25225 6524	0030L742T	Rear Lamp
2515308	F3822KK16	Air Couplings	5 0003 7412	E53853F135	Socket Cable	81 25225 6526	0030L742T	Rear Lamp
2515436	F3822KK16	Air Couplings	5 0003 7414	E53853F135	Socket Cable	81 25225 6469	0030L742T	Rear Lamp
2516886	F3822KK16	Air Couplings	500037412	E53853F135	Socket Cable	81 25228 6034	0030L742T	Rear Lamp
2521369	F3822KK16	Air Couplings	500037414	E53853F135	Socket Cable	81 25228 6036	0030L742T	Rear Lamp
42070652	F3822KK16	Air Couplings	81 51220 8010	F3822KK16	Air Couplings	81 25225 6032	0030LR72	Rear Lamp
42088851	F3822KK16	Air Couplings	81 51220 8012	F3822KK16	Air Couplings	81 25228 6024	0030LR72	Rear Lamp
4841106	F3822KK16	Air Couplings	81 51220 8026	F3822KK16	Air Couplings	81 25228 6030	0030LR72	Rear Lamp
4880365	F3822KK22	Air Couplings	81 51220 8031	F3822KK16	Air Couplings	81 25228 6036	0030LR72	Rear Lamp
6157724	F3822KK22	Air Couplings	81 51220 8045	F3822KK16	Air Couplings	81 25228 6033	0030LR72	Rear Lamp
0000041822854	0250LEDZ	License Plate Light	81 51220 8088	F3822KK16	Air Couplings	81 25225 6033	0030LR72T	Rear Lamp
4162 3079	0250LEDZ	License Plate Light	81 51220 8078	F3822KK16	Air Couplings	81 25228 6034	0030LR72T	Rear Lamp
4162 2954	0250LEDZ	License Plate Light	81 51220 8094	F3822KK16	Air Couplings	81 25228 6030	0030LR72T	Rear Lamp
9444 6126	0084CLED	Outline Marker Light	81 51220 8095	F3822KK16	Air Couplings	81 25228 6035	0030LR72T	Rear Lamp
9444 6126	0084EMK9	Outline Marker Light	81 51220 8097	F3822KK16	Air Couplings	81 25228 6033	0030LR72T	Rear Lamp
9444 6126	0123LEMK9	Outline Marker Light	81 51220 8102	F3822KK16	Air Couplings	81 25225 0118	0030LR742	Rear Lamp
042080028	2617	Plug / Socket	81 51220 8110	F3822KK16	Air Couplings	81 25225 6523	0030LR742	Rear Lamp
4206 0020	2617	Plug / Socket	81 51220 8111	F3822KK16	Air Couplings	81 25225 6525	0030LR742	Rear Lamp
5 0353 2783	2617	Plug / Socket	81 51220 8010	F3822KK16	Air Couplings	81 25225 6529	0030LR742	Rear Lamp
5 0357 5488	2617	Plug / Socket	81 51220 8012	F3822KK16	Air Couplings	81 25225 6530	0030LR742	Rear Lamp
9940 1404	2617	Plug / Socket	81 51220 8026	F3822KK16	Air Couplings	81 25225 6518	0030LR742T	Rear Lamp
4246 9073	E3827FK	Plug / Socket	81 51220 8001	F3822KK16	Air Couplings	81 25225 6523	0030LR742T	Rear Lamp
7826 92	EN381E	Plug / Socket	81 51220 8045	F3822KK16	Air Couplings	81 25225 6525	0030LR742T	Rear Lamp
9444 6124	0021LL	Rear Lamp	81 51220 8068	F3822KK16	Air Couplings	81 25225 6529	0030LR742T	Rear Lamp
9444 6124	0021LR	Rear Lamp	81 51220 8078	F3822KK16	Air Couplings	81 25225 6530	0030LR742T	Rear Lamp
4162 8725	0029LRSK60	Rear Lamp	81 51220 8094	F3822KK16	Air Couplings	81 25225 6033	0205CU	Rear Lamp
4201 3069	0029LRSK60	Rear Lamp	81 51220 8095	F3822KK16	Air Couplings	81 25226 6036	0205CU	Rear Lamp
4162 8726	0029LRSK60	Rear Lamp	81 51220 8097	F3822KK16	Air Couplings	81 25226 8033	0205CU	Rear Lamp
4201 3058	0029LRSK60	Rear Lamp	81 51220 8102	F3822KK16	Air Couplings	81 25228 6011	0205L80	Rear Lamp
03161844	0030CU	Rear Lamp	81 51220 8110	F3822KK16	Air Couplings	81 25229 6040	0205L80	Rear Lamp
0000099463248	0030L71	Rear Lamp	81 51220 8111	F3822KK16	Air Couplings	81 25226 6151	0205L80	Rear Lamp
37108000	0030L71	Rear Lamp	81 51220 8110	F3822KK16	Air Couplings	81 25225 6369	0205L72	Rear Lamp
00401309	0030L71	Rear Lamp	81 51220 8012	F3822KK16	Air Couplings	81 25228 6011	0205L72	Rear Lamp
00403243	0030L71	Rear Lamp	81 51220 8026	F3822KK16	Air Couplings	81 25225 6511	0205L74	Rear Lamp
00403244	0030L71	Rear Lamp	81 51220 8001	F3822KK16	Air Couplings	85 20001 1848	0205L74	Rear Lamp
00403248	0030L71	Rear Lamp	81 51220 8045	F3822KK16	Air Couplings	81 25229 603 7	0205LR60	Rear Lamp
00401940	0030L71	Rear Lamp	81 51220 8078	F3822KK16	Air Couplings	81 25225 6530	0205LR60	Rear Lamp
0000099463245	0030LR71	Rear Lamp	81 51220 8078	F3822KK16	Air Couplings	81 25225 6128	0205LR60	Rear Lamp
37108000	0030LR71	Rear Lamp	81 51220 8094	F3822KK16	Air Couplings	81 25225 6141	0205LR60	Rear Lamp
504883205	0030LR71	Rear Lamp	81 51220 8095	F3822KK16	Air Couplings	81 25229 6010	0205LR60	Rear Lamp
99461929	0030LR71	Rear Lamp	81 51220 8097	F3822KK16	Air Couplings	81 25229 6040	0205LR60	Rear Lamp
99463242	0030LR71	Rear Lamp	81 51220 8102	F3822KK16	Air Couplings	81 25229 6006	0205LR60	Rear Lamp
99463245	0030LR71	Rear Lamp	81 51220 8110	F3822KK16	Air Couplings	81 25228 6005	0205LR60	Rear Lamp
0000007984016	0153CLSK	Rear Lamp	81 51220 8111	F3822KK16	Air Couplings	81 25226 6010	0205LR72	Rear Lamp
0000007984798	0153CLSK	Rear Lamp	34 51220 8000	F3822KK22	Air Couplings	81 25229 6040	0205LR72	Rear Lamp
0000007984880	0153CLSK	Rear Lamp	34 51220 8000	F3822KK22	Air Couplings	81 25225 6532	0205LR74	Rear Lamp
0000009158535	0153CLSK	Rear Lamp	3451220000	F3822KK22	Air Couplings	81 25229 6039	0221CU5B	Rear Lamp
42471138	0153CLSK	Rear Lamp	81 51220 8024	F3822KK22	Air Couplings	81 25102 0031	0361LED	Rear Lamp Round
7981039	0153CLSK	Rear Lamp	81 51220 8024	F3822KK22	Air Couplings	82 00004 5492	0360L	Rear Lamp Round
7984016	0153CLSK	Rear Lamp	81 51220 8024	F3822KK22	Air Couplings	90 81815 0136	0360L	Rear Lamp Round
9939714	0153CLSK	Rear Lamp	81803400778	F3820H19K16	Air Hose	82 25207 6037	0298LUS24V	Revolving Warning Light
0000007981048	0153CRSB	Rear Lamp	81803400779	F3820H19K16	Air Hose	81 25207 6005	0298LUS24V	Revolving Warning Light
0000007984015	0153CRSB	Rear Lamp	81803410012	F3820H19K16	Air Hose	81 25207 6038	0298LUS24V	Revolving Warning Light
7981046	0153CRSB	Rear Lamp	82953400511	F3820H19K16	Air Hose	81 25225 6499	0298LUS	Side Marker Lamp
7984015	0153CRSB	Rear Lamp	28 12526 0825 81	0084CLED	Outline Marker Light	81 25225 6499	0298LUS	Side Marker Lamp
92158530	0153CRSB	Rear Lamp	81 25229 0582	0084CLED	Outline Marker Light	81 25225 6502	0298LUS	Side Marker Lamp
92158536	0153CRSB	Rear Lamp	81 25290 8095	0084CLED	Outline Marker Light	81 25260 6079	0298LUS	Side Marker Lamp
9036713	0153CRSB	Rear Lamp	28 12526 0005 81	0084EMK9	Outline Marker Light	81 25260 6096	0298LUS	Side Marker Lamp
00000180840	0153L12871	Rear Lamp	81 25290 8096	0084FAB09	Outline Marker Light	81 25290 6089	0298LUS	Side Marker Lamp

OE Code	Order No	Product Group	OE Code	Order No	Product Group	OE Code	Order No	Product Group
81 25260 8091	0268LUS	Side Marker Lamp	3875400139	EN3853FUS5	Social Cable	1365995	0030L60	Rear Lamp
81 25260 8105	0268LUS	Side Marker Lamp	A 387 540 0209	EN3853FUS5	Social Cable	1365995	0030L61Y	Rear Lamp
81 25260 8079	0268LUS	Side Marker Lamp	673 540 0539	ES3853FUS5	Social Cable	1365995	0030L61T	Rear Lamp
81 25260 8081	0268LUS	Side Marker Lamp	6735400139	ES3853FUS5	Social Cable	1365995	0030L61T	Rear Lamp
81 25260 8088	0268LUS	Side Marker Lamp	A 000 826 21 04	0268LUS	Rear Lamp	1365995	0030L60	Rear Lamp
81 25260 8089	0268LUS	Side Marker Lamp	A 000 826 19 44	0268LUS	Rear Lamp	1365995	0030L60	Rear Lamp
81 25260 8105	0268LUS	Side Marker Lamp	A 000 826 18 44	0268LUS	Rear Lamp	1365995	0030L60T	Rear Lamp
81252606499	0268LUS	Side Marker Lamp	A 000 826 11 43	0268LUS	Rear Lamp	1365995	0030L60T	Rear Lamp
81252606679	0268LUS	Side Marker Lamp	A 000 826 04 51	5517L	Rear Lamp	20 225 754	0268CU	Rear Lamp
81252606688	0268LUS	Side Marker Lamp	A 000 826 01 64	5517L	Rear Lamp	20 225 899	0268L51	Rear Lamp
81252606692	0268LUS	Side Marker Lamp	A 000 826 05 51	5517R	Rear Lamp	20 225 797	0268R51	Rear Lamp
81252606691	0268LUS	Side Marker Lamp	A 000 826 02 94	5517R	Rear Lamp	20 225 791	030LLED	Rear Lamp
81252606105	0268LUS	Side Marker Lamp	45 30 064 863	0084CLEO	Outline Marker Light	20 225 916	0268LUS24V	Revolving Warning Light
85 20001-3227	0268LUS	Side Marker Lamp	54 30 064 863	0084CLEO	Outline Marker Light	20 225 926	1651LUS	Side Marker Lamp
81 25411 8017	E4207FH	Social Cable	45 30 064 863	0084EMK9	Outline Marker Light	1367170	EN3853FUS5	Social Cable
81 25411 8033	E4207FH	Social Cable	54 30 064 863	0084EMK8	Outline Marker Light	1399745	EN3853FUS5	Social Cable
81 25411 8034	E4207FH	Social Cable	45 30 064 863	0123LEMK9	Outline Marker Light	1771343	EN3853FUS5	Social Cable
81 25411 8043	E4207FH	Social Cable	54 30 064 863	0123LEMK9	Outline Marker Light	1771443	EN3853FUS5	Social Cable
81 25411 8047	E4207FH	Social Cable	5000 442 713	F38229K16	Air Couplings	1864192	EN3853FUS5	Social Cable
81 25411 8056	E4207FH	Social Cable	5000442713	F38229K16	Air Couplings	1904336	EN3853FUS5	Social Cable
82 25449 0064	E4207FH	Social Cable	5000440154	F38229K22	Air Couplings	1947587	EN3853FUS5	Social Cable
81 25411 8038	EN3853FUS5	Social Cable	50 10 293 629	0268LEDZ	License Plate Light	1947592	ES3853FUS5	Social Cable
81 25411 8050	EN3853FUS5	Social Cable	5430 064 863	0084EMK9	Outline Marker Light	050116	F3820H19K16	Air Hose
81 25411 8051	ES3853FUS5	Social Cable	50 00 790 957	2617	Puo / Socket	050117	F3820H19K16	Air Hose
A 000 429 39 30	F38229K16	Air Couplings	5000790957	2617	Puo / Socket	1033511	F3820H19K16	Air Hose
A 000 429 35 30	F38229K16	Air Couplings	5010 589 539	2617	Puo / Socket	1033512	F3820H19K16	Air Hose
A 000 429 56 30	F38229K16	Air Couplings	5010589539	2617	Puo / Socket	1033512	F3820H19K16	Air Hose
A 000 429 61 30	F38229K16	Air Couplings	50 10 589 541	E4707FQ1	Puo / Socket	50116	F3820H19K16	Air Hose
A 000 429 80 30	F38229K16	Air Couplings	50 10 589 542	E4707FQ1	Puo / Socket	50117	F3820H19K16	Air Hose
A 000 429 86 30	F38229K16	Air Couplings	5010589541	E4707FQ1	Puo / Socket	5050116	F3820H19K16	Air Hose
A 000 429 96 30	F38229K16	Air Couplings	5010589542	E4707FQ1	Puo / Socket	5050117	F3820H19K16	Air Hose
A 000 429 35 30	F38229K22	Air Couplings	74 85 113 791	E4707FQ1	Puo / Socket	740599	0268LEDZ	License Plate Light
A 940 820 01 81	0369A	Headlamps	74 85 113 793	E4707FQ1	Puo / Socket	5006827	0268LEDZ	License Plate Light
A 940 820 02 81	0369A	Headlamps	74 85 115 564	E4707FQ1	Puo / Socket	063029	0084CLEO	Outline Marker Light
A 000 826 42 10	03699CL	Headlamps	7485113791	E4707FQ1	Puo / Socket	066616	0084CLEO	Outline Marker Light
A 000 826 43 10	03699CR	Headlamps	7485113793	E4707FQ1	Puo / Socket	1-FZ3LEK0072	0084CLEO	Outline Marker Light
A 000 826 50 50	0268LEDZ	License Plate Light	7485115564	E4707FQ1	Puo / Socket	740305	0084CLEO	Outline Marker Light
A 001 826 76 50	0268LEDZ	License Plate Light	50 00 296 594	0083CU	Rear Lamp	EL0007-0103	0084CLEO	Outline Marker Light
A 000 826 05 56	0084CLEO	Outline Marker Light	50 01 847 588	0083CU	Rear Lamp	066 616	0084EMK9	Outline Marker Light
A 699 544 01 10	0084EMK9	Outline Marker Light	50 01 847 584	0030L742	Rear Lamp	066616	0084EMK9	Outline Marker Light
A 699 723 10 93	0084CLEO	Outline Marker Light	50 01 847 586	0030L742	Rear Lamp	1-FZ3LEK0072	0084EMK9	Outline Marker Light
A 699 544 01 10	0084EMK9	Outline Marker Light	50 01 847 584	0030L742T	Rear Lamp	740 305	0084EMK9	Outline Marker Light
A 699 723 10 93	0084EMK9	Outline Marker Light	50 01 847 586	0030L742T	Rear Lamp	740305	0084EMK9	Outline Marker Light
A 699 544 01 10	0123LEMK9	Outline Marker Light	50 01 847 585	0030L742T	Rear Lamp	066616	0123LEMK9	Outline Marker Light
A 699 723 10 93	0123LEMK9	Outline Marker Light	50 00 808 166	0221CUSB	Rear Lamp	1-FZ3LEK0072	0123LEMK9	Outline Marker Light
A 011 545 26 26	E2318FK	Puo / Socket	50 00 808 172	0221LFR60	Rear Lamp	740305	0123LEMK9	Outline Marker Light
A 004 545 32 20	E3827FK	Puo / Socket	50 10 231 957	0268LUS	Side Marker Lamp	1133925	0368L	Outline Marker Light
A004 545 21 26	EN3811	Puo / Socket	50 10 306 792	0268LUS	Side Marker Lamp	1133926	0368L	Outline Marker Light
A 001 545 06 26	EN3817	Puo / Socket	50 01 832 940	0651LUS	Side Marker Lamp	060110	E2317FK	Puo / Socket
A 003 545 31 26	EN3817	Puo / Socket	50 01 832 941	0651LUS	Side Marker Lamp	060111	E2317FK	Puo / Socket
A 006 545 06 26	EN3817	Puo / Socket	50 01 832 941	0651LUS	Side Marker Lamp	060140	E2318FK	Puo / Socket
A 001 544 83 90	0268LUSK9	Rear Lamp	50 10 306 930	E4215FH45	Social Cable	060140	E2318FK	Puo / Socket
A 001 544 58 03	0268LUSK90	Rear Lamp	5010306930	E4215FH45	Social Cable	054 506	2617	Puo / Socket
A 001 544 81 03	0268LUSK90	Rear Lamp	5010542755	E4215FH45	Social Cable	060106	EN3815	Puo / Socket
A 001 544 82 03	0268LUSK90	Rear Lamp	5010568453	E4215FH40	Social Cable	1023102	EN3815	Puo / Socket
A 001 544 85 03	0268LUSK90	Rear Lamp	7421680290	E4215FH40	Social Cable	1-FZ3LEK0028	EN3815	Puo / Socket
A 002 544 58 03	0268LUSK90	Rear Lamp	50 10 392 008	EN3853FUS5	Social Cable	2629	EN3815	Puo / Socket
A 001 544 58 03	0268LUSK90	Rear Lamp	5010392008	EN3853FUS5	Social Cable	7189	EN3815	Puo / Socket
A 001 544 81 03	0268LUSK90	Rear Lamp	50 10 392 009	ES3853FUS5	Social Cable	064710	EN3816	Puo / Socket
A 001 544 85 03	0268LUSK90	Rear Lamp	5010392009	ES3853FUS5	Social Cable	060138	EN3817	Puo / Socket
A 002 544 58 03	0268LUSK90	Rear Lamp	518 138	F38229K16	Air Couplings	528651	EN3817	Puo / Socket
A 002 544 47 80	0031CU	Rear Lamp	318158	F38229K16	Air Couplings	064711	ES3816	Puo / Socket
A 002 544 96 03	0031LL	Rear Lamp	1904822	F3820H19K16	Air Hose	060515	0021LL	Rear Lamp
A 002 544 66 03	0031LL	Rear Lamp	1304823	F3820H19K16	Air Hose	060515	0021LR	Rear Lamp
A 002 544 59 03	0031LL	Rear Lamp	20158945	F3820H19K16	Air Hose	000-40-073	0284LU	Rear Lamp
A 002 544 97 03	0031LR	Rear Lamp	2060338	F3820H19K16	Air Hose	062774	0284LU	Rear Lamp
A 002 544 55 03	0031LR	Rear Lamp	1 375 384	0268LEDZ	License Plate Light	000-40-070	0284LUS1	Rear Lamp
A 002 544 57 03	0031LR	Rear Lamp	20 223 836	0268LEDZ	License Plate Light	000-40-061	0284LUS1	Rear Lamp
A 002 544 06 90	0195LUR8	Rear Lamp	419 888	0268LEDZ	License Plate Light	063392	0284LUS1	Rear Lamp
A 002 544 06 90	0195LUR8	Rear Lamp	20 223 831	0084CLEO	Outline Marker Light	EL0007-0004	0284LUS1	Rear Lamp
A 002 544 09 03	0195LUR8	Rear Lamp	20 223 908	0084CLEO	Outline Marker Light	060226	0029CUSB	Rear Lamp
A 002 544 0703	0195LUR8	Rear Lamp	20 223 831	0084EMK9	Outline Marker Light	060552	0029LUSK90	Rear Lamp
A 001 540 56 70	0195LUR8	Rear Lamp	20 223 832	0084EMK9	Outline Marker Light	060555	0029LUSK90	Rear Lamp
A 001 540 63 70	0195LUR8	Rear Lamp	20 223 831	0123LEMK9	Outline Marker Light	060565	0029LUSK90	Rear Lamp
A 699 544 03 03	0268L51	Rear Lamp	20 223 578	E2317FK	Puo / Socket	1-FZ3LEK0488	0029LUSK90	Rear Lamp
A 716 285 02 30	0268L51	Rear Lamp	199 406	E2318FK	Puo / Socket	060553	0029LUSK90	Rear Lamp
A 002 544 68 03	0268L72	Rear Lamp	1360800	2617	Puo / Socket	060566	0029LUSK90	Rear Lamp
A 002 544 70 03	0268L72	Rear Lamp	1908565	2617	Puo / Socket	062447	0195CUSB	Rear Lamp
A 699 544 04 03	0268LRS1	Rear Lamp	2 022 3452	2617	Puo / Socket	063047	0195CUSB	Rear Lamp
A 716 285 02 40	0268LRS1	Rear Lamp	302784	2617	Puo / Socket	063988	0195CUSB	Rear Lamp
A 002 544 69 03	0268LR72	Rear Lamp	1318880	E3827FK	Puo / Socket	063988	0195CUSB	Rear Lamp
A 002 544 71 03	0268LR72	Rear Lamp	0 179 530	EN3815	Puo / Socket	EL0007-0016	0195CUSB	Rear Lamp
A 001 544 69 03	0268LED	Rear Lamp Round	179 530	EN3815	Puo / Socket	000-40-065	0195LUSK90	Rear Lamp
A 000 826 59 56	0361LLED	Rear Lamp Round	20 223 816	EN3815	Puo / Socket	000-40-073	0195LUSK90	Rear Lamp
A 001 544 64 03	0368L	Rear Lamp Round	1403837	EN3816	Puo / Socket	062774	0195LUSK90	Rear Lamp
A 000 826 27 58	0268LUS12V	Revolving Warning	2027735	EN3816	Puo / Socket	063392	0195LUSK90	Rear Lamp
A 000 826 37 58	0268LUS24V	Revolving Warning	0 179 529	EN3817	Puo / Socket	EL0007-0004	0195LUSK90	Rear Lamp
A 000 826 73 58	0302LUS12V	Revolving Warning	179 529	EN3817	Puo / Socket	1044276	0195LUSK90	Rear Lamp
A 000 826 57 58	0302LUS24V	Revolving Warning	EN3817	EN3817	Puo / Socket	062286	0195LUSK90	Rear Lamp
A 000 826 74 58	0302LUS24V	Revolving Warning	1403838	ES3816	Puo / Socket	060562	0268L51	Rear Lamp
A 000 540 80 39	E4207FH40	Social Cable	2037736	ES3816	Puo / Socket	062374	0268L51	Rear Lamp
9901003165	E4215FH40	Social Cable	241 227	0021LL	Rear Lamp	5000562	0268L51	Rear Lamp
A 000 540 79 39	E4215FH40	Social Cable	241 227	0021LR	Rear Lamp	020611	0268R51	Rear Lamp
067530155	E4415F3M	Social Cable	20 223 974	0029LRSK90	Rear Lamp	5000561	0268R51	Rear Lamp
A 000 545 67 84	E4415FH0F40	Social Cable	1 380 879	0030CU	Rear Lamp	062447	0268CU	Rear Lamp
067530155	E4415FH	Social Cable	1380879	0030CU	Rear Lamp	063047	0268CU	Rear Lamp
067530155	E4415FHUS20	Social Cable	1365329	0030L60	Rear Lamp	063988	0268CU	Rear Lamp
387 540 0136	EN3853FUS5	Social Cable	1360863	0030L60	Rear Lamp	EL0007-0016	0268CU	Rear Lamp
						066404	030LLED	Rear Lamp Round
						1-FZ3LEK0251	030LLED	Rear Lamp Round

OEM Code	Order No	Product Group
1567 995	F3822KK16	Air Couplings
1567995	F3822KK16	Air Couplings
1584 568	F3822KK16	Air Couplings
1584568	F3822KK16	Air Couplings
2046 7883	F3822KK16	Air Couplings
20467883	F3822KK16	Air Couplings
8157 063	F3822KK16	Air Couplings
8157963	F3822KK16	Air Couplings
1505 064	F3822KK22	Air Couplings
1509064	F3822KK22	Air Couplings
1 114 775 6	0250LLEDZ	License Plate Light
20721495	0250LLEDZ	License Plate Light
4 374 231	0250LLEDZ	License Plate Light
VOE11147756	0250LLEDZ	License Plate Light
351 394	E2317FK	Plug / Socket
795 720	E2317FK	Plug / Socket
11 305 874	E2318FK	Plug / Socket
7 049 710	E2318FK	Plug / Socket
795 719	E2318FK	Plug / Socket
1609076	2617	Plug / Socket
8158175	2617	Plug / Socket
2 052 079	E3627FK	Plug / Socket
2 052 079 4	E3627FK	Plug / Socket
8 180 090 01	E3627FK	Plug / Socket
1077502	EN3616	Plug / Socket
65103345	EN3616	Plug / Socket
2 126 499 5	EN3617	Plug / Socket
3 171 182	EN3617	Plug / Socket
1077503	ES3616	Plug / Socket
65103347	ES3616	Plug / Socket
348 750	0021LL	Rear Lamp
348 750	0021LR	Rear Lamp
3981782	0030CU	Rear Lamp
8142919	0030CU	Rear Lamp
4803218	0030LLED	Rear Lamp Round
1 576 963	0M11LLED	Rear Lamp Round
363 716	0360L	Rear Lamp Round
8 510 443 7	0209LUS24V	Revolving Warning
85 104 437	0209LUS24V	Revolving Warning
1 279 289 7	0278LUS12V	Revolving Warning
4 374 237	0225LUS12V	Revolving Warning
1 062 395	0322LUS24V	Revolving Warning
1 103 925 5	0322LUS24V	Revolving Warning
11 039 255	0322LUS24V	Revolving Warning
2 174 120	0322LUS24V	Revolving Warning
20000174120	0322LUS24V	Revolving Warning
20734485	0236LUS	Side Marker Lamp
84538758	0236LUS	Side Marker Lamp
20730342	E4215FH40	Spiral Cable
21264638	E4215FH40	Spiral Cable
21680280	E4215FH40	Spiral Cable
20409410	EN3853FU35	Spiral Cable
3944910	EN3853FU35	Spiral Cable
20409412	ES3853FU35	Spiral Cable
355669	ES3853FU35	Spiral Cable
3944912	ES3853FU35	Spiral Cable
282641111A	0250LLEDZ	License Plate Light
KDWHL09201	0084CLEO	Outline Marker Light
KDWHL09201	0084LEMKB	Outline Marker Light
KDWHL09201	0123LEMKB	Outline Marker Light
283 945 095 C	0205L80	Rear Lamp
283 945 096 C	0205L80	Rear Lamp
283 945 096C	0205LR80	Rear Lamp
283 945 223F	0205LR80	Rear Lamp
283 945 223F	0205LR80	Rear Lamp
100 941 022	0289LUS12V	Revolving Warning
KDWHL09577	0289LUS12V	Revolving Warning
690 941 087 A	0289LUS24V	Revolving Warning
KDWHL09024	0289LUS24V	Revolving Warning
KDWHL09318	0322LUS12V	Revolving Warning
183 941 087	0322LUS24V	Revolving Warning

www.sertplas.com.tr

 @sertplas

 facebook.com/sertplas

 linkedin.com/company/sertpl

Laiklik Caddesi Hançer Sokak No: 16
Büyükkılıçlı Köyü 34570
Silivri - İstanbul - TURKEY

+(90) 212 748 45 86 Pbx